

GENERAL CATALOGUE

Professional Irrigation 2021 | rain.it

rain



Efficiently irrigate
helping to conserve water



CHI SIAMO COSA FACCIAMO
WHO WE ARE AND WHAT WE DO

CHI SIAMO COSA FACCIAMO

WHO WE ARE AND WHAT WE DO

Rain S.p.A., fondata nel 1968 da Vittorio Stiatti, è oggi una delle prime aziende, sia in Italia che nel mondo, nel campo dell'irrigazione automatizzata. Da 30 anni l'azienda si occupa di irrigare in modo razionale, efficiente e automatico qualunque tipo di parco, giardino o orto, scegliendo e producendo i migliori prodotti che sfruttano le soluzioni tecniche più innovative e creative.

Rain S.p.A., founded in 1968 by Vittorio Stiatti, is nowadays one of the first companies, both in Italy and in the world, in the field of automated irrigation. For 30 years the company has been dealing with irrigation in a rational, efficient and automatic way by choosing and producing the best products that use the most innovative and creative technical solutions.

1.

Family
COMPANY



**Italian Innovation
& Manufacturing Quality**
for a Greener World



**RADICI FORTI
FANNO CRESCERE
OTTIME IDEE**

GREAT IDEAS GROW FROM STRONG ROOTS

LA NOSTRA **STORIA** OUR HISTORY

Nel 1968 il giovane ingegnere Vittorio Stiatti fonda l'azienda Rain S.p.A. Il primo prodotto di grande successo si chiama "Pioggiatore", una centralina elettromeccanica per l'irrigazione. Gli anni '90 e i 2000 sono per Rain una chiave di svolta, con l'entrata in azienda dei figli di Vittorio, il cambiamento della sede da Milano a Cerro Maggiore (MI) e successivamente con l'apertura nel 2004 di una filiale in Francia e nel 2013 in Israele. Attualmente Rain è leader europeo sia nel mercato professionale dell'irrigazione sia nel fai da te ed esporta in tutto il mondo attraverso una capillare rete di vendita.

In 1968 the young engineer Vittorio Stiatti founded Rain S.p.A. The first highly successful product is called "Pioggiatore", an electromechanical control unit for irrigation. The 90s and 2000s are a turning point for Rain, with the entry into the company of Vittorio's sons and the change of the headquarter from Milan to Cerro Maggiore (MI) and subsequently with the opening in 2004 of a branch in France and in 2013 in Israel. Rain is currently the European leader for both the professional irrigation and DIY market and exports all over the world through a widespread sales network.

2.

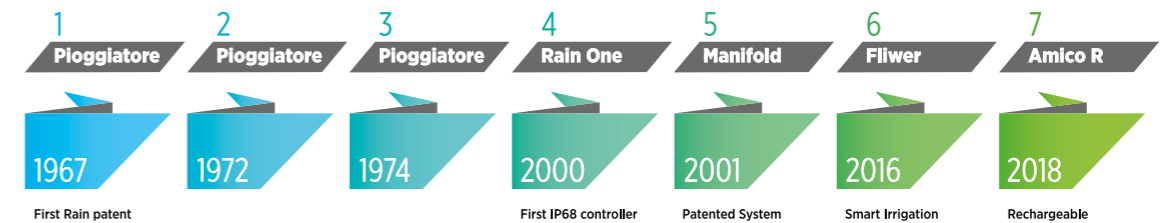

MISSION E VISION

MISSION AND VISION

L'innovazione tecnica e lo sviluppo di nuovi prodotti sono da sempre l'orgoglio e il marchio di fabbrica di Rain. Dai tempi del brevetto della centralina "Pioggiatore®" a quello dell' "etrovalvola con Ghiera pre-montata", sono più di dieci i brevetti detenuti dall'azienda in Europa e nel mondo. Per l'azienda i valori più importanti sono l'innovazione, la tecnologia e il risparmio di risorse, infatti la sua missione è di portare al cliente nuovi vantaggi di natura tecnica, di economicità, di facilità di utilizzo.

Technical innovation and the development of new products have always been Rain's pride and trademark. From the patent of the "Pioggiatore®" controller to the "Solenoid valve with pre-mounted ring", there are now more than ten patents owned by the company in Europe and in the world.

For the company the most important values are innovation, technology and the saving of resources, in fact its mission is to bring new advantages to the customer in the technical, economic field and user-friendliness.

3.





TECNOLOGIA E QUALITÀ
TECHNOLOGY AND QUALITY

SEDI E STABILIMENTI
LOCATIONS AND FACTORIES

TECNOLOGIA E QUALITÀ

TECHNOLOGY AND QUALITY

Rain è un produttore affermato e rispettato nel campo dell'irrigazione. Dalla prima centralina negli anni settanta, fino alla prima valvola elettrica negli anni ottanta, Rain ha sempre cercato di essere il migliore nel design e nella funzionalità del prodotto. Tutto ciò è reso possibile grazie al grande sito di produzione di Cerro Maggiore composto da personale altamente qualificato e un'ingegneria automatizzata che consente una maggiore efficienza produttiva e permette a Rain di rispondere alle esigenze del cliente in pochi giorni. Ogni prodotto inoltre è sottoposto a rigorosi test ed è costantemente monitorato da un sistema interno che fornisce in tempo reale lo stato della produzione.

Rain is an established and respected manufacturer in the irrigation field. Since the first controller in the seventies, to the first electric valve in the eighties Rain has always strived to be the best at product design and functionality. All of this is possible thanks to the large production site in Cerro Maggiore staffed by highly skilled personnel and an automated engineering that allows an higher production efficiency and a really quick response to customer needs. Moreover every product undergoes rigorous testing procedures and is constantly monitored by an internal on line system giving real time production status.

4.



SEDI E STABILIMENTI

LOCATIONS AND FACTORIES

La sede principale e produttiva è a Cerro Maggiore, alle porte di Milano, ed è composta di due insediamenti: uno nel quale si svolge la produzione e hanno sede gli uffici ed un altro limitrofo dove si svolge la logistica e lo stoccaggio del materiale. A Casoria, frazione di Napoli, si trova la sede distaccata che provvede alle spedizioni del centro-sud, a Bordeaux risiede la filiale francese di Rain ed infine in Israele, a Tel Aviv, la sede RAINLINE.

Rain's headquarters is based in Cerro Maggiore, situated close to Milan along the Milan Malpensa motorway. The office consists of two buildings; the main office facility and manufacturing site (2500m2) and the logistic warehouse (300m2). Rain also has an office and warehouse facility in Casoria (NA) dedicated to servicing the central and Southern area of Italy. Internationally, the office and warehouse centre in Bordeaux (France), strategically located to serve the French and Northern European market, and in Tel Aviv (Israel) where the headquarter of RAINLINE is located.

5.





FAMIGLIE PRODOTTI

PRODUCT RANGE

Ad oggi più di 15 linee di prodotti innovativi sono state sviluppate e brevettate, tra cui i pozzetti EZ-Open, dotati di maniglia per una facile apertura, e il Manifold System: una gamma completa di elettrovalvole e collettori per una facile installazione e manutenzione senza paragoni.

La chiave del successo di Rain è sempre stata quella di ascoltare veramente le esigenze, le opinioni e i suggerimenti degli installatori e degli utenti finali. Grazie a questo, Rain è sempre stata in grado di realizzare prodotti diversi da quelli di tutti i concorrenti in termini di estrema praticità di installazione e utilizzo, oltre che di altissima qualità.

To date more than 15 lines of innovative products have been developed and patented, amongst which the EZ-Open valve boxes, equipped with handle for easy opening, and the Manifold System: a complete range of solenoid valves and manifolds for a easy installation and a maintenance with no comparison.

The key to success of Rain has always been to really listen to the needs, opinions and suggestions of installers and end users. Thanks to this, Rain has always been able to create products that were different from all the Competitors' ones in terms of extreme practicality of installation and use, as well as of the highest quality.

6.



RCOON VISION SYSTEM



SELF-RECHARGEABLE

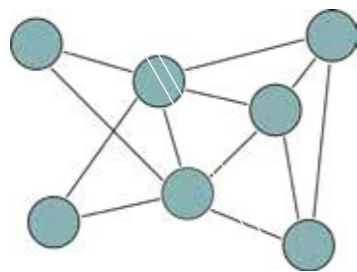

INTERCONNECTED



1.
**LA NOSTRA IDEA D'IMPIANTO
D'IRRIGAZIONE DEL FUTURO**

OUR IDEA OF THE IRRIGATION SYSTEM OF THE FUTURE

2.
**UN SISTEMA D'IRRIGAZIONE
AUTOSUFFICIENTE**

A SELF-SUFFICIENT IRRIGATION SYSTEM

3.
**ENERGETICAMENTE INDIPENDENTE
E INTERCONNESO**

ENERGETICALLY SELF-SUFFICIENT AND INTERCONNECTED

AMICO VISION



Programmatore da rubinetto
Tap timer



Caratteristiche di programmazione

Interfaccia di programmazione: Dial, Rain Vision APP
1 programma
1 partenza per programma
Tempi di irrigazione: da 1 min a 240 min
Frequenza d'irrigazione: 6 ore - 15 giorni
One look display: - Ora - Ora di partenza - Durata irrigazione - Frequenza irrigazione
Indicazione prossima irrigazione
Indicazione frequenza
Visualizzazione tempo residuo di irrigazione
Segnalazione batterie scariche
Memoria non volatile (i programmi restano in memoria anche senza alimentazione)
compatibile con IOS e Android

Programming Characteristics

Programming interface: Dial Rain Vision APP
1 program
1 Start Time per Program
Run time min/max: 1/240 minutes
Watering frequency: from every 6 hours up to once 15 days
One look display: - Current time indication - Start time indication - Duration of watering indication - Frequency indication
Next irrigation indication
Frequency indication
Watering countdown
Low battery function
Non-volatile memory (it saves programs also without power)
compatible with IOS and Adroid

Caratteristiche tecniche

- Tipo di batteria: Li-ion 18650 2000mAh 3.6V
- solenoidi bistabili
- Numero di zone: 1 - 2
- Ingresso 3/4"-1" F
- Uscita 3/4" M
- ingresso sensore pioggia
- Ingresso Micro-USB per ricarica
- corpo in ABS
- coperchio di protezione
- Centralina removibile
- Display: 3" VA Glass
- Connettività: Bluetooth 5.0
- Max. distanza di comunicazione: fino a 50
- Elettrovalvola a membrana
- Pressione minima di lavoro: 1 bar
- Pressione massima di lavoro: 6 bar
- Portata minima: 5 l/min
- Portata massima: 40 l/min
- Temperatura di funzionamento: 4 - 70°C
- Compatibile per ricarica con Onda e Luce
- Compatibile con Next per connessione wi-fi

Technical characteristics

- Type of power: Li-ion 18650 2000mAh 3.6V
- Solenoid Latching
- Number of Zones: 1 - 2
- Inlet thread 3/4"-1" F
- Outlet thread 3/4" M
- Rain Sensor input
- Micro-USB inlet for recharge
- ABS Body
- Protection cover
- Removable control unit
- Display: 3" VA Glass
- Connectivity: Bluetooth 5.0
- Max. communication distance: up to 50
- Diaphragm electric valve
- Min. working pressure: 1 bar
- Max. working pressure: 6 bar
- Min. flow: 5 l/min
- Max. flow: 40 l/min
- Operation Temperature: 4-70°C
- Compatible with Onda and Luce for recharge
- Compatible with Next for wi-fi connection

Models

- AMICO VISION - 1 ZONA / 1 ZONE
- AMICO 2 VISION - 2 ZONE / 2 ZONES

AMICO PRO VISION



Programmatore da pozzetto IP68
IP68 valve box controller



Caratteristiche di programmazione

Interfaccia di programmazione: pulsanti e Rain Vision APP
1 programma
1 partenza per programma
Tempi di irrigazione: zona 1: da 1 min a 240 min zona 2 e 4: da 1 a 180 min
Frequenza d'irrigazione: 6 ore - 15 giorni
One look display: - Ora - Ora di partenza - Durata irrigazione - Frequenza irrigazione
Indicazione prossima irrigazione
Indicazione frequenza
Visualizzazione tempo residuo di irrigazione
Segnalazione batterie scariche
Memoria non volatile (i programmi restano in memoria anche senza alimentazione)
compatibile con IOS e Android

Programming Characteristics

Programming interface: Dial Rain Vision APP
1 program
1 Start Time per Program
Run time min/max: 1 zone: 1/240 minutes 2,4 zone: 1/180 min
Watering frequency: from every 6 hours up to once 15 days
One look display: - Current time indication - Start time indication - Duration of watering indication - Frequency indication
Next irrigation indication
Frequency indication
Watering countdown
Low battery function
Non-volatile memory (it saves programs also without power)
compatible with IOS and Adroid

Caratteristiche tecniche

- Tipo di batteria: Li-ion 18650 2000mAh 3.6V
- solenoidi bistabili 9Vdc AMP
- Numero di zone: 1 - 2 - 4
- ingresso sensore pioggia
- Ingresso Micro-USB IP68 per ricarica
- corpo in ABS
- coperchio di protezione
- Display: 3" VA Glass
- Connettività: Bluetooth 5.0
- Max. distanza di comunicazione: fino a 50
- Elettrovalvola convenzionale
- Temperatura di funzionamento: -10 - 85°C
- Compatibile per ricarica con Onda e Luce
- Compatibile con Next per connessione wi-fi

Technical characteristics

- Type of power: Li-ion 18650 2000mAh 3.6V
- 9 Vdc AMP Solenoid Latching
- Number of Zones: 1 - 2 - 4
- Rain Sensor input
- IP68 Micro-USB inlet for recharge
- ABS Body
- Protection cover
- Display: 3" VA Glass
- Connectivity: Bluetooth 5.0
- Max. communication distance: up to 50
- Conventional electric valve
- Operation Temperature: -10 - 85°C
- Compatible with Onda and Luce for recharge
- Compatible with Next for wi-fi connection

Models

- IP68 AMICO PRO VISION - 1 ZONA / 1 ZONE
- IP68 AMICO PRO VISION - 2 ZONE / 2 ZONES
- IP68 AMICO PRO VISION - 4 ZONE / 4 ZONES

PURE VISION



Programmatore da pozzetto IP68
IP68 valve box controller



Caratteristiche di programmazione	Programming Characteristics
Interfaccia di programmazione: Rain Vision APP	Programming interface: Rain Vision APP
Memoria non volatile (i programmi restano in memoria anche senza alimentazione)	Non-volatile memory (it saves programs also without power)
compatibile con IOS e Android	compatible with IOS and Adroid

Caratteristiche tecniche	Technical characteristics
<ul style="list-style-type: none"> Tipo di batteria: Li-ion 18650 2000mAh 3.6V solenoidi bistabili 9Vdc AMP Numero di zone: 1 - 2 - 4 - 6 ingresso sensore pioggia Ingresso ricarica con connettore IP68 corpo in ABS Connettività: Bluetooth 5.0 Max. distanza di comunicazione: fino a 50 Elettrovalvola convenzionale Temperatura di funzionamento: -10 - 85°C Compatibile per ricarica con Onda e Luce Compatibile con Next per connessione wi-fi 	<ul style="list-style-type: none"> Type of power: Li-ion 18650 2000mAh 3.6V 9Vdc AMP Solenoid Latching Number of Zones: 1 - 2 - 4 - 6 Rain Sensor input IP68 recharge input connection ABS Body Connectivity: Bluetooth 5.0 Max. communication distance: up to 50 Conventional electric valve Operation Temperature: -10 - 85°C Compatible with Onda and Luce for recharge Compatible with Next for wi-fi connection

Models
IP68 PURE VISION - 1 ZONA / 1 ZONE
IP68 PURE VISION - 2 ZONE / 1 ZONES
IP68 PURE VISION - 4 ZONE / 4 ZONES
IP68 PURE VISION - 6 ZONE / 6 ZONES

NUVOLA PLUG IN VISION



Accessorio da interno
Indoor Accessory



Caratteristiche di programmazione	Programming Characteristics
Interfaccia di programmazione: Rain Vision APP	Programming interface: Rain Vision APP
compatibile con IOS e Android	compatible with IOS and Android

Caratteristiche tecniche	Technical characteristics
<ul style="list-style-type: none"> 230Vac 50 Hz (Caricatore USB esterno 5Vdc - 1A) corpo in ABS Connettività: Bluetooth 5.0 e WI-FI Max. distanza di comunicazione: fino a 50 Temperatura di funzionamento: -10 - 85°C 	<ul style="list-style-type: none"> 230Vac 50 Hz (External USB Charger 5Vdc - 1A) ABS Body Connectivity: Bluetooth 5.0 and WI-FI Max. communication distance: up to 50 Operation Temperature: -10 - 85°C

RAIN VISION APP



Applicazione per cellulare
Mobile Application



Caratteristiche di programmazione	Programming Characteristics
1 programma	1 program
2 partenze per programma	2 Start Times per Program
Tempi di irrigazione: da 1 min a 240 min	Run time min/max: 1/240 minutes
regolazione stagionale: 10 - 200 % (versione pro)	water budgeting: 10 - 200 % (pro version)
Sens Start: Ingresso sensore pioggia programmabile per zona (versione pro)	Sens Start: Rain Sensor Input, programmable per each station (pro version)
Pump Start: Ingresso pompa programmabile per zona (versione pro)	Pump Start: pump relay Input, programmable per each station (pro version)
Frequenza d'irrigazione: <ul style="list-style-type: none"> 6 ore - 14 giorni (versione basic) personalizzabile (versione pro) 	Watering frequency: <ul style="list-style-type: none"> 6 hours up to once 15 days fully customizable
Partenza manuale (versione basic)	Manual start (basic version)
Partenza manuale smart (versione pro)	Smart manual start (pro version)

Models
NUVOLA PLUG IN VISION
RAIN VISION APP

VISION SYSTEM

VISION SYSTEM
VISION SYSTEM
CENTRALINE RICARICABILI RECHARGEABLE CONTROLS
CENTRALINE DA RUBINETTO TAP TIMERS
CENTRALINE IP68 CONTROLLERS
CENTRALINE CONTROLLERS
ELETTROVALVOLE ELECTRIC VALVES
POZZETTI VALVE BOXES
RACCORDI PVC PVC FITTINGS
IRRIGATORI SPRINKLERS
MICROIRRIGAZIONE DRIP LINE
HOME IRRIGATION



LUCE VISION



Pannello solare
Solar panel



Caratteristiche tecniche

- Uscita di ricarica IP68 compatibile con dispositivi vision e ricaricabili
- intervallo di temperatura: -10 - 85°C

Technical characteristics

- IP68 Recharge output compatible with Vision and Rechargeable devices
- Temperature range -10 - 85°C



Models
IP68 PANNELLO SOLARE / SOLAR PANNEL LUCE VISION
IP68 MICROTURBINA / MICROTURBINE ONDA VISION



ONDA VISION



Microturbina
Microturbine



Caratteristiche tecniche

- Filettatura in ingresso: 1" M
- Filettatura in uscita: 1" M
- Uscita di ricarica IP68 compatibile con dispositivi vision e ricaricabili
- Massima tensione generata: 6.8 Vdc
- Massima potenza generata: 2 W
- Corpo in fibra di vetro PA6 30%
- IP68
- 4 diversi ugelli per adattarsi a qualsiasi sistema di irrigazione:
 - 33% - Bassa portata: da 10 a 18 l / min (consigliato)
 - 66% - Portata media: da 16 a 30 l / min (consigliata)
 - 80% - Portata elevata: da 24 a 36 l / min (consigliata)
 - 100% - Portata massima: da 30 a 50 l / min (consigliata)
- Portata massima: 70 l/min
- Pressione minima di lavoro: 1 bar
- Pressione massima di lavoro: 6 bar
- Temperatura di funzionamento: 4-70°C
- Dimensioni: 120 mm x 49 mm x 65 mm
- Peso: 400 g

Technical characteristics

- Inlet thread: 1" M
- Outlet thread: 1" M
- IP68 Recharge output compatible with Vision and Rechargeable devices
- Maximum voltage generated: 6.8 Vdc
- Maximum power generated: 2 W
- Body material: PA6 30% fibreglass
- IP68
- 4 different nozzles to adapt to any irrigation system:
 - 33% - Low Flow rate: from 10 to 18 l/min (suggested)
 - 66% - Medium Flow rate: from 16 to 30 l/min (suggested)
 - 80% - High Flow rate: from 24 to 36 l/min (suggested)
 - 100% - Top Flow rate: from 30 to 50 l/min (suggested)
- Maximum flow: 70 l/min
- Min. working pressure: 1 bar
- Max. working pressure: 6 bar
- Operation Temperature: 4-70°C
- Dimensions: 120 mm x 49 mm x 65 mm
- Weight: 400 g

Dettagli del connettore di ricarica

- diametro: 5 mm
- lunghezza: 5 m
- materiale: PVC
- conduttori: 2x0.5 mm²
- Connettore rapido femmina IP68 a 2 poli (max diameter: 18 mm)

Charging connector details

- diameter: 5 mm
- length: 5 m
- material: PVC
- conductors: 2x0.5 mm²
- 2 poles IP68 female quick connector (max diameter: 18 mm)

VISION SYSTEM

VISION SYSTEM
VISION SYSTEM
CENTRALINE RICARICABILI
RECHARGEABLE CONTROLS
CENTRALINE DA RUBINETTO
TAP TIMERS
CENTRALINE IP68
CONTROLLERS
CENTRALINE
CONTROLLERS
ELETTROVALVOLE
ELECTRIC VALVES
POZZETTI
VALVE BOXES
RACCORDI PVC
PVC FITTINGS
IRRIGATORI
SPRINKLERS
MICROIRRIGAZIONE
DRIP LINE
HOME IRRIGATION

CENTRALINE RICARICABILI

RECHARGEABLE
CONTROLLERS



1. **FUNZIONANO SENZA CORRENTE ELETTRICA**
THEY WORK WITHOUT POWER SUPPLY

2. **LE INSTALLI DOVE VUOI**
YOU CAN INSTALL THEM WHEREVER YOU WANT

3. **LE RICARICHI SFRUTTANDO L'ENERGIA CHE HAI GIÀ**
YOU RECHARGE THEM WITH ECO-ENERGY

ENERGETICAMENTE INDIPENDENTI

ENERGETICALLY SELF-SUFFICIENT

RECHARGEABLE LITHIUM BATTERY

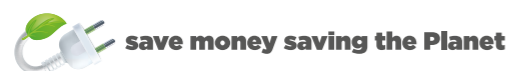

DISCOVER THE **R**GENERATION

C-DIAL R | I-DIAL R | AMICO R

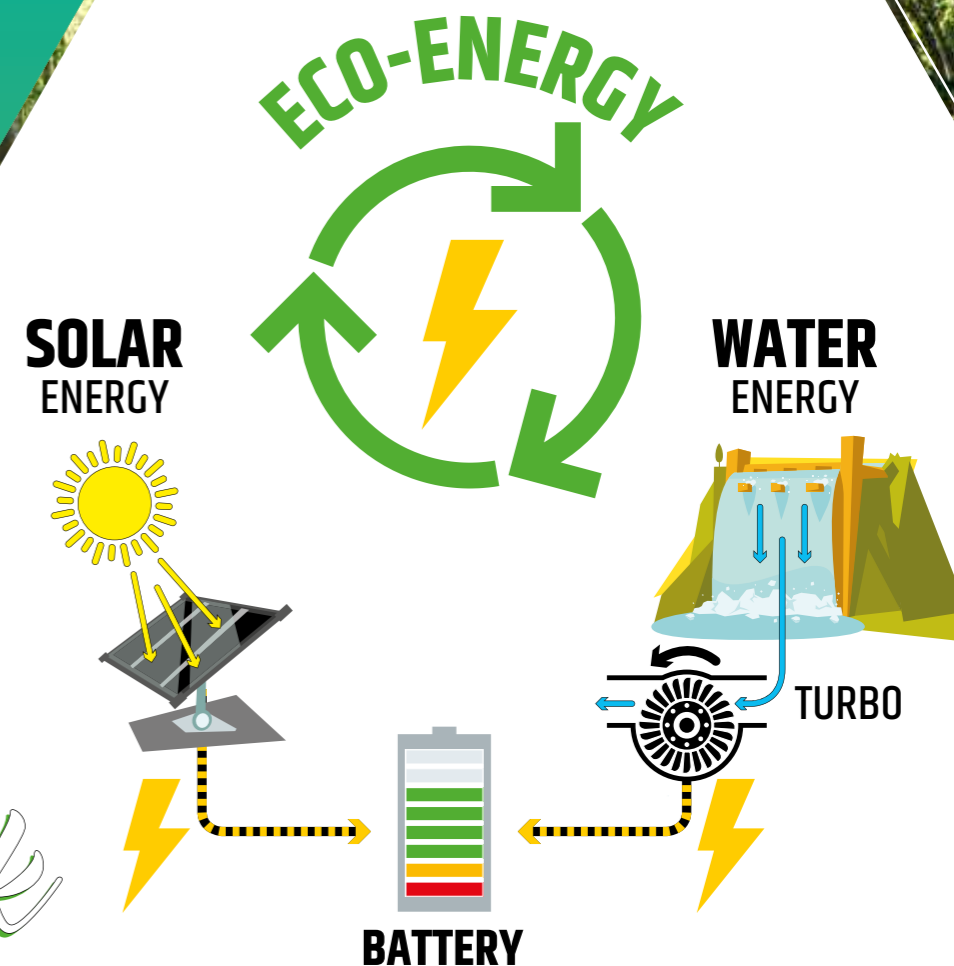

Think
GREEN

AMICO R1 AMICO R2

Programmatore da rubinetto ricaricabile
Tap timer rechargeable



Caratteristiche di programmazione

- 1 programma
- Tempi di irrigazione: da 1 min a 240 min
- Frequenza d'irrigazione: minimo 1 partenza ogni 15 giorni massimo 1 partenza ogni 6 ore
- One look display:
 - Ora
 - Ora di partenza
 - Durata irrigazione
 - Frequenza irrigazione
- Indicazione prossima irrigazione
- Segnalazione batterie scariche

Programming Characteristics

- 1 program
- Run time min/max: 1/240 minutes
- Watering frequency: from every 6 hours up to once 15 days
- One look display:
 - Current time indication
 - Start time indication
 - Duration of watering indication
 - Frequency indication
- Next irrigation indication
- Low battery function

Caratteristiche tecniche

- 1 zona / 2 zone
- Ingresso 3/4"-1" F (acciaio)
- Uscita 3/4" M
- Pressione minima di lavoro 1.0 bar
- Pressione massima di lavoro 6 bar
- Portata minima di lavoro 5 l/min
- Portata massima 40 l/min
- Elettrovalvola a membrana 9 Vdc
- Centralina removibile
- Corpo in ABS
- Coperchio di protezione per il display LDC
- Display retroilluminato da 3" LCD
- Batteria al lithium ricaricabile
- Batteria da 2000 mAh
- Ingresso Micro-USB
- Ingresso sensore pioggia (connettore jack)
- Compatibile per ricarica con Onda e Luce

Technical characteristics

- 1 zone / 2 zones
- Inlet thread 3/4"-1" F (steel)
- Outlet thread 3/4" M
- Min working pressure 1.0 bar
- Max working pressure 6 bar
- Min flow 5 l/min
- Max flow 40 l/min
- Diaphragm 9 Vdc electric valve
- Removable control unit
- ABS Body
- Hard plastic cover for LDC display protection
- Wide backlit 3" LCD display
- Powered by Lithium battery
- 2000 mAh Battery
- Micro-USB inlet
- Rain sensor input (jack connection)
- Compatible with Onda and Luce for recharge

Code	Models
200.4093502	AMICO R1- 1 ZONA (English label) / 1 ZONE (English label)
200.4043502	AMICO R2- 2 ZONE (English label) / 2 ZONES (English label)

I-DIAL R OUTDOOR

Programmatore da parete ricaricabile
Wall-mounted rechargeable controller



Caratteristiche di programmazione

- Interfaccia di programmazione: bottoni
- 4 programmi
- 4 partenze (1 partenza per ogni programma)
- Tempi di irrigazione: 1 - 240 min
- Regolazione stagionale da 10% a 200%
- Sens Start: Ingresso sensore pioggia programmabile per zona
- Programma d'irrigazione per giorni settimanali o per intervalli da 1 giorno a 19 giorni
- Visualizzazione prossima irrigazione
- Visualizzazione tempo residuo di irrigazione
- Segnalazione batterie scariche
- Memoria non volatile (i programmi restano in memoria anche senza alimentazione)

Programming Characteristics

- Programming interface: Buttons
- 4 programs
- 4 start times (1 per each program)
- Run Times: 1 - 240 min
- Water Budgeting from 10% to 200%
- Sens Start: Rain Sensor Input, programmable per each station
- Watering frequency: 7 days calendar with individual day selection, or 1 to 19 days interval watering
- Next irrigation indication
- Watering countdown
- Low-battery function
- Non-volatile memory (it saves programs also without power)

Caratteristiche tecniche

- Batteria ricaricabile: Li-ion 18650 2000mAh 3.6V
- solenoidi bistabili 9 Vdc latching
- 4, 6 e 8 zone
- Modello Outdoor
- Ingresso sensore pioggia
- Ingresso Micro-USB IP68 per ricarica
- Green Energy: due metodi di ricarica: pannello solare e turbina ad acqua
- Corpo in ABS
- Sportello protettivo
- Schermo illuminato 3"
- Valvola Convenzionale
- Temperatura di funzionamento: -10 - 85°C
- Compatibile per ricarica con Onda e Luce

Technical characteristics

- Rechargeable Battery: Li-ion 18650 2000mAh 3.6V
- 9 Vdc solenoid latching
- 4, 6 and 8 zones
- Outdoor Model
- Rain Sensor input
- IP68 Micro-USB inlet for recharge
- Green Energy: two charging methods: Solar Panel and Water Turbine
- ABS Body
- Protective cover
- 3" Backlit display
- Conventional Valve
- Operation Temperature: -10 - 85°C
- Compatible with Onda and Luce for recharge

Code	Models
200.4381340	I-DIAL-R OUTDOOR 4 ZONES - RICARICABILE / RECHARGEABLE
200.4381360	I-DIAL-R OUTDOOR 6 ZONES - RICARICABILE / RECHARGEABLE
200.4381380	I-DIAL-R OUTDOOR 8 ZONES - RICARICABILE / RECHARGEABLE

PACKAGING E ISTRUZIONI

PACKAGING AND INSTRUCTIONS

Il nuovo concetto di packaging di Rain cerca di rispondere alle esigenze di un mercato ormai internazionale e cerca di agevolare il consumatore con una più facile ed intuitiva lettura delle specifiche del prodotto. Per fare ciò, da quest'anno le caratteristiche di molti prodotti Rain sono state tradotte in 22 lingue differenti e sui packaging sono state inserite icone di facile interpretazione con relativa descrizione.

Rain's new packaging concept tries to meet the needs of an international market and tries to make it easier for the consumer to read the characteristics of the product. To make this possible, since this year the features of many Rain products have been translated into 22 different languages and smart-icons with relative description have been added on the packaging.

22

LINGUE
LANGUAGES



NUOVO LAYOUT

NEW LAYOUT

I nuovi manuali d'istruzione vi guideranno nella programmazione della vostra centralina attraverso l'utilizzo di disegni e icone, e in caso di necessità, potrete scaricare le istruzioni in formato pdf e le video istruzioni dal codice QR posizionato sulle centraline.

The new instruction manuals will guide you in the programming of your control unit through the use of drawings and icons, and if necessary, you can download the pdf instructions and the video - instructions from the QR code placed on the control units.



NUOVO LOGO

NEW LOGO

3 EASY STEPS: una programmazione facile ed intuitiva in soli tre semplici passaggi!

3 EASY STEPS: an easy and smart programming in just three simple steps!



ICONE E SIMBOLI

ICON SYSTEM

Le nuove icone di facile interpretazione aiuteranno il cliente nella scelta della centralina più idonea alle sue esigenze.

The new smart-icons will help the customer in choosing the most suitable controller for his needs.



22

LINGUE
LANGUAGES

Le 22 lingue presenti sulle nuove confezioni permetteranno di rispondere alle esigenze di un mercato ormai internazionale.

The 22 languages on the new packagings will allow to meet the needs of an international market.

SCHEMA DI INSTALLAZIONE

GRAPHIC REPRESENTATION OF THE SYSTEM

La rappresentazione grafica dell'impianto guiderà il cliente nella scelta della centralina più idonea alle sue esigenze.

The graphic representation of the system will guide the customer in choosing the most suitable control unit for his needs.

TAP TIMERS

Nel 2013 Rain intraprende la strada per la realizzazione di una nuova centralina da rubinetto che rispecchi le esigenze del settore dell'irrigazione. Le nostre ricerche di mercato hanno fatto emergere il bisogno di una centralina facile da programmare e con i dati di programmazione sempre visibili. Per questo motivo abbiamo realizzato una centralina che risponde a 3 semplici domande:

- A CHE ORA irrigare
- PER QUANTO TEMPO irrigare
- OGNI QUANTO irrigare

Da questa semplice idea nasce il concetto di programmazione in "3 EASY STEPS".

In 2013 Rain starts to develop a new tap timer control unit that reflects the irrigation market needs. Research has shown the need of a control unit easy to program and user friendly. For this reason we created a controller that follows 3 simple steps :

- WHEN to irrigate
- HOW MUCH to irrigate
- HOW OFTEN to irrigate

From this simple idea comes the "3 EASY STEPS" programming concept.

FUNZIONI AVANZATE ADVANCED FUNCTION



01
SCHERMO ONE LOOK
ONE LOOK DISPLAY

02
ATTACCO CON RINFORZO IN METALLO
INLET STEEL

03
3 EASY STEPS

04
UNITÀ ELETTRONICA RIMOVIBILE
DETACHABLE CONTROL

01
SCHERMO ONE LOOK. Lo schermo consente una visione immediata della programmazione memorizzata. Inoltre lo schermo retro illuminato garantisce una chiara visione delle informazioni in tutte le condizioni di luminosità.

ONE LOOK DISPLAY. The screen allows an immediate view of the programming. In addition, the backlit screen ensures a clear view of the information in all lighting conditions.

Amico +, Amico D

02
ATTACCO CON RINFORZO IN METALLO. L'attacco al rubinetto rinforzato in acciaio garantisce una migliore resistenza e durata nel tempo della centralina.

INLET STEEL. The reinforced steel tap connection guarantees better resistance and durability of the control unit.

Amico D

03
3 EASY STEPS. La speciale programmazione in tre semplici passaggi consente una programmazione facile ed intuitiva.

3 EASY STEPS. The special programming in three simple steps allows easy and intuitive programming.

Amico +, Amico D

04
UNITÀ ELETTRONICA RIMOVIBILE. L'unità elettronica rimovibile consente una comoda programmazione e una veloce manutenzione dell'elettrovalvola.

DETACHABLE CONTROL. The removable electronic unit allows convenient programming and quick maintenance of the solenoid valve.

Amico +, Amico D

CENTRALINE DA RUBINETTO
TAP TIMERS

TAP TIMER	CLICK	CLICK+	CLICK BLUETOOTH	CLICK MIST	AMICO+	AMICO D
CARATTERISTICHE PRINCIPALI / MAIN FEATURES						
Numero di zone Number of zones	1	1	1	1	1 e 2	1 e 2
Tempi di irrigazione Watering duration	2-5-10-15 min	2-5-10-15 min	2-5-10-15 min	5-10-20-30 sec	1+240 min	1+240 min
Partenze giornaliere massime Max daily start times	2	2	2	1.440	4	4
Tipo di batterie Type of batteries	2x1,5 Volt AAA	2x1,5 Volt AAA	2x1,5 Volt AAA	2x1,5 Volt AAA	2x1,5 Volt AA	2x1,5 Volt AA
CARATTERISTICHE TECNICHE / TECHNICAL FEATURES						
Attacco Inlet	3/4"-1"	3/4"-1"	3/4"-1"	3/4"-1"	3/4"-1"	3/4"-1"
Attacco con rinforzo in metallo Stainless steel inlet	○	○	○	○	○	●
Portata Flow	5+25 l/min	5+25 l/min	5+25 l/min	5+25 l/min	5+40 l/min	5+40 l/min
Pressione Pressure	1+4 bar	1+4 bar	1+4 bar	1+4 bar	1+6 bar	1+6 bar
Tipo di programmazione Type of programming	one click	one click	one click	one click	3 Easy steps	3 Easy steps
Schermo one look One look display	○	○	○	○	●	●
Bluetooth	○	○	●	○	○	○
Sensore pioggia Rain sensor	○	○	○	○	○	●

CLICK

Programmatore da rubinetto
Tap timer



CLICK PLUS CLICK BLUETOOTH CLICK MIST

Rain Click è la soluzione più semplice ed estremamente facile da programmare per il tuo balcone. L'unica cosa che devi fare è scegliere la combinazione di durata e di frequenza del tuo ciclo di irrigazione. La programmazione non è mai stata così facile e veloce!

Rain Click is the most simple and extremely easy to set allow to control irrigation on your balcony, little garden. The only thing you have to do is to choose the combination of frequency and duration of your irrigation cycle. Programming has never been so easy and fast!

Caratteristiche di programmazione	Complete user-friendly programming
12 programmi	12 programs
Tempi di irrigazione: 2 min, 5 min, 10 min e 15 min	Run time: 2 min, 5 min, 10 min and 15 min
Frequenza di irrigazione: 12 h, 24 h e 48 h	Frequency every: 12 h, 24 h and 48 h
Segnalazione batterie scariche	Low battery function



Caratteristiche tecniche

- 1 zona
- Attacco rubinetto: 3/4"-1"
- Uscita: 3/4"
- Portata min.: 5 l/min
- Portata max.: 25 l/min
- Pressione min.: 1.0 bar
- Pressione max.: 4.0 bar
- Elettrovalvola 9 VDC a membrana
- Corpo in ABS
- Alimentata con 2 batterie alcaline 1.5 volt (AAA)

Technical characteristics

- 1 zone
- Inlet thread: 3/4"-1"
- Outlet thread: 3/4"
- Min flow: 5 l/min
- Max flow: 25 l/min
- Min bar: 1.0 bar
- Max bar: 4.0 bar
- Diaphragm 9 VDC electric valve
- ABS Body
- Powered by 2 alkaline 1.5 volt (AAA)

Code	Models
200.6800100	CLICK - 1 ZONA / 1 ZONE
200.6800300	CLICK BLUETOOTH - 1 ZONA / 1 ZONE
200.6800400	CLICK MIST - 1 ZONA / 1 ZONE
200.6800200	CLICK PLUS - 1 ZONA / 1 ZONE

CLICK PLUS



Rain Click Plus è l'evoluzione di Rain Click. Estremamente facile da impostare per il controllo dell'irrigazione del tuo balcone o del tuo piccolo giardino. L'unica cosa che devi fare è impostare la frequenza e la durata e in automatico il programmatore ripeterà il ciclo da te deciso. Rain Click Plus ha una funzione ritardo partenza per permettere maggiore flessibilità alla partenza del ciclo di irrigazione.

Rain Click Plus is the evolution of the Rain Click. Extremely easy to set allow to control irrigation on your balcony or small garden. The only thing you have to do is to set the frequency and the duration and automatically the controllers will repeat the cycle you decide. Rain Click Plus has a built in delay function to give you even more flexibility to start irrigation cycle.

Caratteristiche di programmazione
12 programmi
Tempi di irrigazione: 2 min, 5 min, 10 min e 15 min
Frequenza di irrigazione: 12 h, 24 h e 48 h
Segnalazione batterie scariche
Funzione partenza ritardata
Complete user-friendly programming
12 programs
Run time: 2 min, 5 min, 10 min and 15 min
Frequency every: 12 h, 24 h and 48 h
Low battery function
Select delay first start time

CLICK BLUETOOTH



Rain Click Bluetooth è l'evoluzione della Rain Click. Estremamente facile da impostare manualmente come una normale click ma anche tramite smart phone con una semplice APP dedicata. L'APP permette di impostare una specifica ora di partenza e di scegliere tra i programmi preimpostati.

Rain Click Bluetooth is the connected evolution of the Rain Click. It is extremely easy to set as a normal click manually but also through a smart phone with an easy and dedicated APP. The APP allows setting a specific start time and choosing between the pre-set programs.

Caratteristiche di programmazione
12 programmi
Tempi di irrigazione: 2 min, 5 min, 10 min e 15 min
Frequenza di irrigazione: 12 h, 24 h e 48 h
Segnalazione batterie scariche
App Bluetooth (Android e iPhone)
Start time
Complete user-friendly programming
12 programs
Run time: 2 min, 5 min, 10 min and 15 min
Frequency every: 12 h, 24 h and 48 h
Low battery function
Controlled by App (Android and iPhone)
Start time

CLICK MIST



Rain Click Mist è la soluzione perfetta per le applicazioni a pioggia. I programmi consistono in rapidi cicli di pioggia a piccoli intervalli, ideata specificatamente per rinfrescare durante la stagione calda.

Rain Click Mist is the perfect solution for misting applications. Programs are quick cycles of misting with small intervals, studied specifically to refresh during the hot season.

Caratteristiche di programmazione
12 programmi
Tempi di irrigazione: 5 sec, 10 sec, 20 sec e 30 sec
Frequenza di irrigazione: 1 min, 2 min e 5 min
Segnalazione batterie scariche
Complete user-friendly programming
12 programs
Run time: 5 sec, 10 sec, 20 sec and 30 sec
Frequency every: 1 min, 2 min and 5 min
Low battery function

CENTRALINE DA RUBINETTO
TAP TIMERS

VISION SYSTEM
VISION SYSTEM
CENTRALINE RICARICABILI
RECHARGEABLE CONTROLS
CENTRALINE DA RUBINETTO
TAP TIMERS
CENTRALINE IP68
CONTROLLERS
CENTRALINE
CONTROLLERS
ELETTROVALVOLE
ELECTRIC VALVES
POZZETTI
VALVE BOXES
RACCORDI PVC
PVC FITTINGS
IRRIGATORI
SPRINKLERS
MICROIRRIGAZIONE
DRIP LINE
HOME IRRIGATION



AMICO+ AMICO+2

Programmatore da rubinetto
Tap timer



AMICO D AMICO D2

Programmatore da rubinetto
Tap timer



Caratteristiche di programmazione

1 programma
Tempi di irrigazione: da 1 min a 240 min
Frequenza di irrigazione: da 4 partenze giornaliere a 1 partenza ogni 15 giorni
One look display: - Ora attuale - Ora di partenza - Durata irrigazione - Frequenza irrigazione
Indicazione prossima irrigazione
Indicazione frequenza
Visualizzazione tempo residuo di irrigazione
Segnalazione batterie scariche

Complete user-friendly programming

1 program
Run time min/max: 1/240 minutes
Watering frequency: from every 6 hours up to once 15 days
One look display: - Current time indication - Start time indication - Duration of watering indication - Frequency indication
Next irrigation indication
Frequency indication
Watering countdown
Low battery function

Caratteristiche tecniche

- 1 zona / 2 zone
- Attacco 3/4" - 1" F
- Uscita 3/4" M
- Alimentata con 2 batterie alcaline 1.5 volt (AA)
- Materiale di fabbricazione ABS
- Coperchio di chiusura
- Parte elettronica estraibile
- Schermo retroilluminato
- Valvola a membrana
- Pressione minima di lavoro 1.0 bar
- Pressione massima di lavoro 6 bars
- Portata minima di lavoro 5 l/min
- Portata massima 40 l/min

Technical characteristics

- 1 zone / 2 zones
- Inlet thread 3/4"-1" F
- Outlet thread 3/4" M
- Powered by 2 alkaline 1.5 volt (AA)
- ABS Body
- Hard plastic cover
- Removable control unit
- Wide backlit 3" LCD display
- Diaphragm 9 VDC electric valve
- Min bar 1.0 bar
- Max working pressure 6 bars
- Min flow 5 l/min
- Max flow 40 l/min

Code	Models
200.4094500	AMICO + 1 ZONA / 1 ZONE
200.4044500	AMICO +2 2 ZONE / 2 ZONES

Caratteristiche di programmazione

1 programma
Tempi di irrigazione: da 1 min a 240 min
Frequenza di irrigazione: da 4 partenze giornaliere a 1 partenza ogni 15 giorni
One look display: Indicazione dell'ora attuale Indicazione dell'ora di partenza Indicazione della durata di irrigazione Indicazione della frequenza di irrigazione
Indicazione prossima irrigazione
Visualizzazione tempo residuo di irrigazione
Segnalazione batterie scariche

Complete user-friendly programming

1 program
Run time min/max: 1/240 minutes
Watering frequency: from every 6 hours up to once 15 days
One look display: Current time indication Start time indication Duration of watering indication Frequency indication
Next irrigation indication
Watering countdown
Low battery function

Code	Models
200.4092500	AMICO DIAL 1 1 ZONA / 1 ZONE
200.4092502	AMICO DIAL 2 2 ZONE / 2 ZONES

Caratteristiche tecniche

- 1 zona / 2 zone
- Ingresso 3/4"-1" F (acciaio)
- Uscita 3/4" M
- Pressione minima di lavoro 1.0 bar
- Pressione massima di lavoro 6.0 bars
- Portata minima di lavoro 5 l/min
- Portata massima 40 l/min
- Elettrovalvola a membrana 9 Vdc
- Centralina removibile
- Corpo in ABS
- Coperchio di protezione per il display LCD
- Display retroilluminato da 3" LCD
- Alimentata da 2x1.5 V AA batterie alcaline (non incluse)
- Ingresso sensore pioggia (connettore jack)

Technical characteristics

- 1 zone / 2 zones
- Inlet thread 3/4"-1" F (steel)
- Outlet thread 3/4" M
- Min bar 1.0 bar
- Max working pressure 6.0 bars
- Min flow 5 l/min
- Max flow 40 l/min
- Diaphragm 9 Vdc electric valve
- Removable control unit
- ABS Body
- Hard plastic cover for LCD display protection
- Wide backlit 3" LCD display
- Electrical Power Supply 2x1.5 V AA alkaline batteries (not included)
- Rain sensor input (jack connection)



IP68

Dal grande successo delle centraline da rubinetto Amico + e dall'esperienza ventennale di Rain nel mercato delle centraline da pozzetto nascono le nuove linee di programmatori IP68 Rain:

Amico PRO che rispecchia al 100% i canoni di facilità di programmazione dell' AMICO +. W-DIAL, presentata all'EIMA 2018, unisce la filosofia di programmazione "3 EASY STEPS" a funzionalità professionali per soddisfare ogni esigenza.

Inoltre W-DIAL è anche compatibile con l'esclusivo sistema di intelligenza artificiale RAINOLVE che permette di risparmiare fino al 70% d'acqua.



Combining the great success of the Amico + with Rain's twenty years of experience in valve box controllers, a new line of IP68 controllers was developed:

Amico PRO which fully reflects the ease of use and the quick installation of AMICO +.

W-DIAL, presented at EIMA 2018, that combines the "3 EASY STEPS" programming with professional features, to meet every needs.

In addition W-DIAL is also compatible with the exclusive RAINOLVE artificial intelligence system that allows to save up to 70% of water.

FUNZIONI AVANZATE

ADVANCED FUNCTION

01
SCHERMO ONE LOOK
ONE LOOK DISPLAY

02
CONNESSIONE RAPIDA
QUICK CONNECTION

03
BLUETOOTH

04
RAINOLVE SYSTEM

01
SCHERMO ONE LOOK. Lo schermo consente una visione immediata della programmazione memorizzata. Inoltre lo schermo retro illuminato garantisce una chiara visione delle informazioni in tutte le condizioni di luminosità.

ONE LOOK DISPLAY. The screen allows an immediate view of the programming. In addition, the backlit screen ensures a clear view of the information in all lighting conditions.

Amico PRO, W-Dial

02
CONNESSIONE RAPIDA. L'esclusiva connessione rapida stagna consente un'installazione veloce senza l'utilizzo di connettori elettrici e una rapida manutenzione dell'elettrovalvole.

QUICK CONNECTION. The unique waterproof quick connection allows quick installation without the use of electrical connectors and quick maintenance of the solenoid valves.

Amico PRO, TBD, W-Dial

03
BLUETOOTH. La tecnologia BLUETOOTH consente una programmazione remota senza dover aprire il pozzetto. Inoltre, la speciale APP professionale GARDEN WIZ consente una programmazione elastica per soddisfare ogni tipo di esigenza d'irrigazione.

BLUETOOTH. Technology allows remote programming without having to open the valve box. In addition, the special professional GARDEN WIZ APP allows the programming to meet all types of irrigation needs.

TBD

04
RAINOLVE SYSTEM. Il logo "fluer inside" indica la compatibilità del prodotto con l'esclusivo sistema di intelligenza artificiale RAINOLVE che consente un risparmio d'acqua fino al 70%.

RAINOLVE SYSTEM. The "fluer inside" logo indicates the compatibility of the product with the exclusive RAINOLVE artificial intelligence system, which allows water savings of up to 70%.

W-Dial

IP68	AMICO PRO 1	AMICO PRO 2 e 4	TBD	W-DIAL
CARATTERISTICHE PRINCIPALI / MAIN FEATURES				
Numero di zone <i>Number of zones</i>	1	2 e 4	1-2-4-6	1-2-4-6
Tempi di irrigazione <i>Watering duration</i>	1+240 min	1+180 min	1+1439 min	1+240 min
Numero di programmi <i>Number of programs</i>	2	2	-	4
Partenze giornaliere massime <i>Max daily start times</i>	4	4	-	288
Tipo di batterie <i>Type of batteries</i>	2x1,5 Volt AA	2x1,5 Volt AA	2x1,5 Volt AA	4x1,5 Volt AA
CARATTERISTICHE TECNICHE / TECHNICAL FEATURES				
Solenoidi <i>Solenoids</i>	9 Vdc	9 Vdc	9 Vdc	9 Vdc
Display	3"	3"	○	3"
Bluetooth	○	○	●	○
Sensore pioggia <i>Rain Sensor</i>	●	●	●	●
Schermo one look <i>One look display</i>	●	●	○	●
Compatibile con RAINOLVE <i>Compatible with RAINOLVE</i>	○	○	○	●
Tipo di programmazione <i>Type of programming</i>	3 Easy steps	3 Easy steps	Bluetooth	3 Easy steps



AMICO PRO

Programmatore da pozzetto IP68
IP68 valve box controller

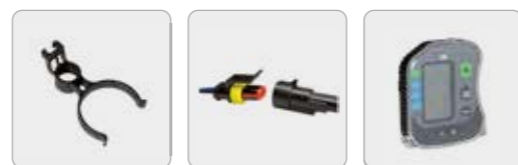

Caratteristiche di programmazione

- 2 programmi
- Indicazione dell'ora di partenza
- Tempi di irrigazione: da 1 min a 240 min AMICO PRO
- Tempi di irrigazione: da 1 min a 180 min AMICO PRO 2 e 4
- Frequenza d'irrigazione per programma: da 6 ore fino a 15 giorni
- Indicazione prossima irrigazione
- Massimo 8 partenze giornaliere
- Minimo 1 partenza ogni 15 giorni
- Visualizzazione tempo residuo di irrigazione
- Segnalazione batterie scariche
- Memoria non volatile (i programmi restano in memoria anche senza alimentazione)

Complete user-friendly programming

- 2 programs
- Start time indication
- Run time min/max: 1/240 minutes AMICO PRO
- Run time min/max: 1/180 minutes AMICO PRO 2 and 4
- Watering frequency for each program: from every 6 hours up to once 15 days
- Next irrigation indication
- Up to 8 start times per day
- Minimum 1 start time every 15 days
- Watering countdown
- Low battery function
- Non-volatile memory (it saves programs also without power)

Caratteristiche tecniche

- 1, 2 e 4 zone
- Alimentata con 2 batterie alcaline 1.5 volt (AA)
- Materiale di fabbricazione ABS
- Coperchio di chiusura
- Schermo retroilluminato da 3"
- 9 Vdc latching (solenoidi bistabili)
- Tenuta stagna (IP68)
- Collegamento sensore pioggia (cavo rosso)
- Staffa centralina per pozzetti "EzOPEN"

Technical characteristics

- 1, 2 and 4 zones
- Powered by 2 alkaline 1.5 volt (AA)
- ABS case
- Hard plastic cover
- Wide backlit 3" LCD display
- 9 Vdc latching
- IP68
- Rain sensor Input (red cable)
- Bracket for valve boxes "EzOPEN"

Code	Models
200.4064500	IP68 AMICO PRO 1 ZONA / 1 ZONE
200.4064200	IP68 AMICO PRO 2 ZONE / 2 ZONES
200.4064400	IP68 AMICO PRO 4 ZONE / 4 ZONES
200.4064560	KIT IP68 AMICO PRO 1 ZONA (1 ZONE) + E.V. 150 1" M/UN
200.4064590	KIT IP68 AMICO PRO 1 ZONA (1 ZONE) + E.V. 150 1" F



W-DIAL

Programmatore da pozzetto IP68
IP68 valve box controller

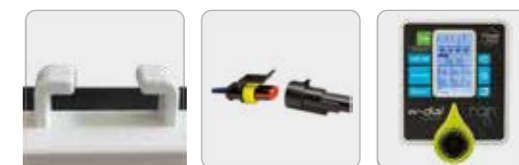

Caratteristiche di programmazione

- 4 programma
- 3 partenze per programma
- Tempi di irrigazione: da 1 min a 240 min
- Frequenza di irrigazione: per giorni della settimana o intervalli orari o giornalieri
- One look display:
Indicazione dell'ora attuale
Indicazione dell'ora di partenza
Indicazione della durata di irrigazione
Indicazione della frequenza di irrigazione
- Indicazione prossima irrigazione
- Visualizzazione tempo residuo di irrigazione
- Segnalazione batterie scariche
- Partenza manuale smart

Complete user-friendly programming

- 4 programs
- 3 start time per program
- Run time min/max: 1/240 minutes
- Watering frequency: Irrigation frequency: weekly calendar or hours/days interval
- One look display:
Current time indication
Start time indication
Duration of watering indication
Frequency indication
- Next irrigation indication
- Watering countdown
- Low battery function
- Smart manual start

Caratteristiche tecniche

- 1, 2, 4 e 6 zone
- Staffa centralina per pozzetti "EzOPEN"
- Collegamento sensore pioggia due fili meccanico (cavo rosso)
- Tenuta stagna (IP68)
- 9 Vdc latching (solenoidi bistabili)
- Corpo in ABS
- Display retroilluminato da 3"
- Alimentata con 2 batterie alcaline 1.5 volt (AA)
- Compatibile con il sistema RAINOLVE

Technical characteristics

- 1, 2, 4, 6 zones
- Bracket for valve boxes "EzOPEN"
- Rain sensor Input (red cable)
- IP68
- 9 Vdc latching
- ABS Body
- Wide backlit 3" LCD display
- Powered by 2 alkaline 1.5 volt (AA)
- RAINOLVE compatible

Code	Models
172.1590000	IP68 W-DIAL 1 ZONA (1 ZONE) + SOLENOID 9VDC
172.1590900	KIT IP68 W-DIAL 1 ZONA (1 ZONE) + E.V. 150 1" F
172.1590915	KIT IP68 W-DIAL 1 ZONA (1 ZONE) + E.V. 150 1" M/UN
172.2590000	IP68 W-DIAL 2 ZONE / 2 ZONES
172.4590000	IP68 W-DIAL 4 ZONE / 4 ZONES
172.6590000	IP68 W-DIAL 6 ZONE / 6 ZONES

CENTRALINE IP68
IP68 CONTROLLERS

VISION SYSTEM
VISION SYSTEM

CENTRALINE RICARICABILI
RECHARGEABLE CONTROLS

CENTRALINE DA RUBINETTO
TAP TIMERS

CENTRALINE IP68
CONTROLLERS

CENTRALINE
CONTROLLERS

ELETTROVALVOLE
ELECTRIC VALVES

POZZETTI
VALVE BOXES

RACCORDI PVC
PVC FITTINGS

IRRIGATORI
SPRINKLERS

MICROIRRIGAZIONE
DRIP LINE

HOME IRRIGATION



CENTRALINE 24 VAC

CONTROLLERS 24 VAC

Lo strepitoso successo del sistema "3 EASY STEPS", nato nel 2014 con la centralina da rubinetto AMICO+, ha consentito a Rain di introdursi nel mercato delle centraline d'irrigazione elettroniche con i modelli C-DIAL, I-DIAL ed ELITE. Ad oggi Rain produce più di 300.000 centraline elettroniche quantità destinata ad aumentare grazie alla nascita della versione I-DIAL 12 zone.

Rain completa la gamma delle sue centraline elettroniche con la centralina S-DIAL. Una centralina con programmazione touchscreen che può arrivare fino a 192 partenze a giorno e che con la connessione a RAINOLVE SYSTEM può raggiungere funzionalità infinite grazie ad una piattaforma di monitoraggio in continua evoluzione

The amazing success of the "3 EASY STEPS" philosophy, born in 2014 with the AMICO +, allowed Rain to enter in the market of electronic controllers.

The models developed are the C-DIAL, I-DIAL and ELITE and they differs in the ease of programming.

Nowadays Rain produces more than 300,000 electronic controllers per year and this quantity will increase thanks to the new 12-zone I-DIAL version.

the S-DIAL completes the range of Rain's electronic controllers. This controllers has a touchscreen and can reach up to 192 starts per day. In addition S-DIAL is compatible with RAINOLVE SYSTEM and it can have infinite functionalities thanks to a constantly evolving monitoring platform.

FUNZIONI AVANZATE

ADVANCED FUNCTION



- 01 BACKLIT DISPLAY
- 02 TOUCH SCREEN
- 03 3 EASY STEPS
- 04 RAINOLVE SYSTEM

24 VAC	C-DIAL	I-DIAL INDOOR	I-DIAL OUTDOOR	ELITE INDOOR	ELITE OUTDOOR	S-DIAL
CARATTERISTICHE PRINCIPALI / MAIN FEATURES						
Numero di zone Number of zones	4 e 6	4-6-8-12	4-6-8-12	4-6-8-10	4-6-8-10	6-8-12-16
Tempi di irrigazione Watering duration	1+240 min	1+240 min	1+240 min	1+240 min	1+240 min	1+240 min
Numero di programmi Number of programs	2	4	4	4	4	3
Partenze giornaliere massime Max daily start times	4	4	4	4	4	192
Alimentazione Power supply	24 VAC INDOOR	24 VAC INDOOR	24 VAC OUTDOOR	24 VAC INDOOR	24 VAC OUTDOOR	24 VAC OUTDOOR
CARATTERISTICHE TECNICHE / TECHNICAL FEATURES						
Solenoidi Solenoids	24 VAC	24 VAC	24 VAC	24 VAC	24 VAC	24 VAC
Display	3"	3"	3"	3"	3"	3"
Sensore pioggia Rain sensor	●	●	●	●	●	●
Compatibile con RAINOLVE Compatible with RAINOLVE	○	○	○	○	○	●
Tipo di programmazione Type of programming	3 Easy steps	3 Easy steps	3 Easy steps	3 Easy steps	3 Easy steps	Touchscreen

01
BACKLIT DISPLAY. Lo schermo retro illuminato garantisce una chiara visione delle informazioni in tutte le condizioni di luminosità.

BACKLIT DISPLAY. The backlit screen ensures a clear view of the information in all lighting conditions.

I-Dial, S-Dial

02
TOUCH SCREEN. Lo schermo touchscreen consente una navigazione rapida delle schermate e una selezione dei dati intuitiva come sul tuo Smartphone.

TOUCH SCREEN. The touchscreen allows quick screen navigation and intuitive data selection just like on your Smartphone.

S-Dial

03
3 EASY STEPS. La speciale programmazione in tre semplici passaggi consente una programmazione facile ed intuitiva.

3 EASY STEPS. The special programming in three simple steps allows easy and intuitive programming.

I-Dial, S-Dial

04
RAINOLVE SYSTEM. Il logo "flower inside" indica la compatibilità del prodotto con l'esclusivo sistema di intelligenza artificiale RAINOLVE che consente un risparmio d'acqua fino al 70%.

RAINOLVE SYSTEM. The "flower inside" logo indicates the compatibility of the product with the exclusive RAINOLVE artificial intelligence system, which allows water savings of up to 70%.

S-Dial

12
ZONES

New I-Dial



C-DIAL

Programmatore da parete
Wall-mounted controller



Caratteristiche di programmazione

2 programma
2 partenze per programma
Tempi di irrigazione: da 1 min a 240 min
Frequenza di irrigazione: da 4 partenze al giorno a 1 partenza alla settimana
Programma di irrigazione: calendario settimanale con selezione del giorno
Regolazione stagionale da 10% al 200%
Indicazione prossima irrigazione
Funzione OFF
Segnalazione batterie scariche
Memoria permanente

Complete user-friendly programming

2 programs
2 start times per program
Run time min/max: 1/240 minutes
Watering cycles: from 4 per day up to 1 per week
Watering Schedule: 7 day calendar with individual day selection
Water Budgeting Mode from 10% to 200%
Next irrigation indication
Freeze-program function (OFF)
Low battery function
Permanent Memory Saves programs during power outages

Caratteristiche tecniche

- 4 e 6 zone
- Trasformatore esterno:
 - Alimentazione: 220 VAC 50-60 Hz
 - Uscita elettrica: 24 Volts AC, 0.8 AMP
- Valvola Master /Pompa 24 VAC output
- Batterie tampone 2 x 1.5 volt AA alcaline che mantengono in memoria i programmi impostati
- Ingresso sensore pioggia
- Tasto reset
- Tasto clear

Technical characteristics

- 4 and 6 zones
- External Transformer
 - Electrical Power Supply: 220 VAC 50-60 Hz
 - Electrical Outputs: 24 Volts AC, 0.8 AMP
- Master Valve/Pump 24 VAC output
- Power Failure: 2 x 1.5 volt AA alkaline battery permanently maintains clock. (not included)
- Rain sensor input
- Reset button
- Clear button

Code	Models
200.4180410	C-DIAL 24VAC INDOOR 4 ZONE / 4 ZONES
200.4180610	C-DIAL 24VAC INDOOR 6 ZONE / 6 ZONES
200.8500450	TRASFORMATORE / TRANSFORMER 220V - 24V AC



I-DIAL INDOOR

Programmatore da parete
Wall-mounted controller



Caratteristiche di programmazione

4 programma
1 partenze per programma
Tempi di irrigazione: da 1 min a 240 min
Frequenza di irrigazione: da 4 partenze al giorno a 1 partenza alla settimana
Programma di irrigazione: calendario settimanale con selezione del giorno, per intervalli da 1 a 19 giorni
Regolazione stagionale da 10% al 200%
Indicazione prossima irrigazione
Funzione OFF
Segnalazione batterie scariche
Memoria permanente

Complete user-friendly programming

4 program
1 start times per program
Run time min/max: 1/240 minutes
Watering cycles: from 4 per day up to 1 per week
Watering Schedule: 7 day calendar with individual day selection, or 1 to 19 day interval watering
Water Budgeting Mode from 10% to 200%
Next irrigation indication
Freeze-program function (OFF)
Low battery function
Permanent Memory Saves programs during power outages

Caratteristiche tecniche

- 4, 6, 8 e 12 zone
- Trasformatore esterno:
 - Alimentazione: 220 VAC 50-60 Hz
 - Uscita elettrica: 24 Volts AC, 0.8 AMP
- Valvola Master /Pompa 24 VAC output
- Batterie tampone 2 x 1.5 volt AA alcaline che mantengono in memoria i programmi impostati
- Sens Start: Ingresso sensore pioggia programmabile per zona
- Pump Start: Ingresso pompa programmabile per zona
- Ingresso sensore pioggia
- Schermo retro illuminato

Technical characteristics

- 4, 6, 8 and 12 zones
- External Transformer
 - Electrical Power Supply: 220 VAC 50-60 Hz
 - Electrical Outputs: 24 Volts AC, 0.8 AMP
- Master Valve/Pump 24 VAC output
- Power Failure: 2 x 1.5 volt AA alkaline battery permanently maintains clock. (not included)
- Sens Start: Rain Sensor Input, programmable per each station
- Pump Start: pump relay Input, programmable per each station
- Rain sensor input
- Wide backlit LCD display

Code	Models
200.4080410	I-DIAL 24VAC INDOOR 4 ZONE / 4 ZONES
200.4080610	I-DIAL 24VAC INDOOR 6 ZONE / 6 ZONES
200.4080810	I-DIAL 24VAC INDOOR 8 ZONE / 8 ZONES
200.4081210	I-DIAL 24VAC INDOOR 12 ZONE / 12 ZONES
200.8500450	TRASFORMATORE / TRANSFORMER 220V - 24V AC



I-DIAL OUTDOOR

Programmatore da parete
Wall-mounted controller



Caratteristiche di programmazione

- 4 programma
- 1 partenze per programma
- Tempi di irrigazione: da 1 min a 240 min
- Frequenza d'irrigazione: da 4 al giorno a 1 ogni 19 giorni
- Programma di irrigazione: calendario settimanale con selezione del giorno, per intervalli da 1 a 19 giorni
- Regolazione stagionale da 10% al 200%
- Indicazione prossima irrigazione
- Funzione OFF
- Segnalazione batterie scariche
- Memoria permanente

Complete user-friendly programming

- 4 program
- 1 start times per program
- Run time min/max: 1/240 minutes
- Watering cycles: from 4 per day, up to 1 each 19 days
- Watering Schedule: 7 day calendar with individual day selection, or 1 to 19 day interval watering
- Water Budgeting Mode from 10% to 200%
- Next irrigation indication
- Freeze-program function (OFF)
- Low battery function
- Permanent Memory Saves programs during power outages

Caratteristiche tecniche

- 4, 6, 8 e 12 zone
- Trasformatore esterno:
 - alimentazione: 220 VAC 50-60 Hz
 - Electrical Outputs: 24 Volts AC, 1.0 AMP
- Master Valve/Pump 24 VAC output
- Power Failure: 2 x 1.5 volt AA alkaline battery permanently maintains clock. (not included)
- Sens Start: Ingresso sensore pioggia programmabile per zona
- Pump Start: Ingresso pompa programmabile per zona
- Ingresso sensore pioggia
- Schermo retro illuminato

Technical characteristics

- 4, 6, 8 and 12 zones
- External Transformer:
 - Electrical Power Supply: 220 VAC 50-60 Hz
 - Electrical Outputs: 24 Volts AC, 1.0 AMP
- Master Valve/Pump 24 VAC output
- Power Failure: 2 x 1.5 volt AA alkaline battery permanently maintains clock. (not included)
- Sens Start: Rain Sensor Input, programmable per each station
- Pump Start: pump relay Input, programmable per each station
- Rain sensor input
- Wide backlit LCD display

Code	Models
200.4083410	I-DIAL 24VAC OUTDOOR 4 ZONE/ 4 ZONES
200.4083610	I-DIAL 24VAC OUTDOOR 6 ZONE/ 6 ZONES
200.4083810	I-DIAL 24VAC OUTDOOR 8 ZONE/ 8 ZONES
200.4083121	I-DIAL 24VAC OUTDOOR 12 ZONE/ 12 ZONES



ELITE

Programmatore da parete
Wall-mounted controller



Caratteristiche di programmazione

- 4 partenze per singola stazione
- Tempi di irrigazione: da 1 min a 240 min
- Frequenza di irrigazione: da 4 partenze al giorno a 1 ogni 15 giorni
- Indicazione prossima irrigazione
- Funzione OFF
- Segnalazione batterie scariche
- Memoria permanente

Complete user-friendly programming

- 4 start times per each station
- Run time min/max: 1/240 minutes
- Watering Cycles per each station : from 4 per day, up to 1 every 15 days
- Next irrigation indication
- Freeze-program function (OFF)
- Low battery function
- Permanent Memory Saves programs during power outages

Caratteristiche tecniche

- 4, 6, 8 e 10 zone
- Modello Indoor/ Outdoor
- Versione 9 Vdc: Alimentazione 4 x 1.5 volt AA alkaline (non incluse)
- Versione 24 Vac: Batterie tampone 2 x 1.5 volt AA alkaline (non incluse)
- trasformatore esterno incluso nella versione 24 Vac:
 - Alimentazione 220 VAC 50Hz
 - Electrical Outputs: 24 Volts AC, 1.0 AMP
- Regolazione stagionale da 10% a 200%
- Ingresso sensore pioggia
- Schermo retroilluminato

Technical characteristics

- 4, 6, 8, 10 zones
- Indoor & Outdoor version
- Power Failure in the 9 Vdc version: 4 x 1.5 volt AA alkaline battery (not included)
- Power Failure in the 24 Vac version: 2 x 1.5 volt AA alkaline battery (not included)
- Transformer included in the 24 Vac version:
 - Electrical Power Supply: 220 VAC 50Hz
 - Electrical Outputs: 24 Volts AC, 1.0 AMP
- Water Budgeting Function. From 10% to 200%
- Rain Sensor Inlet,
- Wide backlit LCD display

Code	Models
200.4580410	ELITE 24VAC INDOOR 4 ZONE / 4 ZONES
200.4580610	ELITE 24VAC INDOOR 6 ZONE / 6 ZONES
200.4580810	ELITE 24VAC INDOOR 8 ZONE / 8 ZONES
200.4581010	ELITE 24VAC INDOOR 10 ZONE / 10 ZONES
200.4581340	ELITE 9VDC OUTDOOR 4 ZONE / 4 ZONES
200.4581360	ELITE 9VDC OUTDOOR 6 ZONE / 6 ZONES
200.4581380	ELITE 9VDC OUTDOOR 8 ZONE / 8 ZONES
200.4581310	ELITE 9VDC OUTDOOR 10 ZONE / 10 ZONES

Code	Models
200.4581410	ELITE 9VDC INDOOR 4 ZONE / 4 ZONES
200.4581610	ELITE 9VDC INDOOR 6 ZONE / 6 ZONES
200.4581810	ELITE 9VDC INDOOR 8 ZONE / 8 ZONES
200.4581110	ELITE 9VDC INDOOR 10 ZONE / 10 ZONES
200.4583410	ELITE 24VAC OUTDOOR 4 ZONE / 4 ZONES
200.4583610	ELITE 24VAC OUTDOOR 6 ZONE / 6 ZONES
200.4583810	ELITE 24VAC OUTDOOR 8 ZONE / 8 ZONES
200.4583110	ELITE 24VAC OUTDOOR 10 ZONE / 10 ZONES



S-DIAL OUTDOOR

Programmatore da parete
Wall-mounted controller



Caratteristiche di programmazione

- 4 programmi
- 2 partenze per programma
- Tempi di irrigazione: da 1 min a 240 min
- Frequenza di irrigazione: da 192 partenze al giorno a 1 ogni 99 giorni
- Programma di irrigazione: programmazione settimanale o per intervallo (giorni/ore)
- Indicazione prossima irrigazione
- Funzione OFF
- Segnalazione batterie scariche
- Memoria permanente
- Partenza manuale smart

Complete user-friendly programming

- 4 programs
- 2 start times per program
- Run time min/max: 1/240 minutes
- Watering cycles: from 192 per day up to 1 every 99 days
- Watering Schedule: Weekly calendar or frequency by interval
- Next irrigation indication
- Freeze-program function (OFF)
- Low battery function
- Permanent Memory Saves programs during power outages
- Smart manual start

Caratteristiche tecniche

- 6, 9, 12 e 16 zone
- Trasformatore esterno:
 - alimentazione: 220 VAC 50-60 Hz
 - Electrical Outputs: 24 Volts AC, 1.0 AMP
- Master Valve/Pump 24 VAC output
- Power Failure: 2 x 1.5 volt AA alkaline battery permanently maintains clock. (not included)
- Ingresso sensore pioggia e flussimetro
- Pump Start: Ingresso pompa programmabile per zona
- Schermo touchscreen
- Connessione 220 VAC IP68
- Connessione radio per RAINOLVE System

Technical characteristics

- 6, 9, 12 and 16 zones
- External Transformer:
 - Electrical Power Supply: 220 VAC 50-60 Hz
 - Electrical Outputs: 24 Volts AC, 1.0 AMP
- Master Valve/Pump 24 VAC output
- Power Failure: 2 x 1.5 volt AA alkaline battery permanently maintains clock. (not included)
- Rain Sensor and flowmeter Input
- Pump Start: pump relay Input, programmable per each station
- Touchscreen display
- connection 220 Vac IP68
- Radio connection to RAINOLVE System

Code	Models
200.5800600	S-DIAL 24VAC OUTDOOR 6 ZONE / 6 ZONES
200.5800900	S-DIAL 24VAC OUTDOOR 9 ZONE / 9 ZONES
200.5801200	S-DIAL 24VAC OUTDOOR 12 ZONE / 12 ZONES
200.5801600	S-DIAL 24VAC OUTDOOR 16 ZONE / 16 ZONES

ACQUA CLICK 2 WIRES

Sensore Pioggia
Rain Sensor

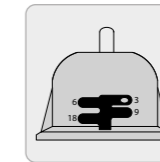

Il sensore pioggia impedisce al sistema di irrigazione di irrigare durante la pioggia.

The Rain Sensor prevents your irrigation system from watering during a rain.

Caratteristiche tecniche

- Compatibile con tutti i tipi di controller (sia a batteria che a 24 Vac)
- Braccio snodato
- Cablaggio normalmente chiuso
- Regolabile: 3, 6, 9, 18 mm
- Lunghezza cavo: 7,5 m (incluso)
- Dischi igroscopici per l'assorbimento delle acque meteoriche
- Alta flessibilità per qualsiasi installazione (parete, palo, tetto, grondaia, ecc.)
- Due fascette incluse

Technical characteristics

- Compatible with all types of controllers (both battery-powered and 24 Vac)
- Flexible support
- Wiring normally closed
- Adjustable: 3, 6, 9 and 18 mm
- Cable length: 7.5 m (included)
- Hygroscopic discs for the absorption of rainwater
- High flexibility for any installation (wall, pole, roof, gutter, etc.)
- Two cable ties included

Code	Models
210.5005300	ACQUA CLICK 2 FILI / 2 WIRES



ELETTROVALVOLE ELECTRIC VALVES	150	JAR-TOP	155	160	180
CARATTERISTICHE PRINCIPALI / MAIN FEATURES					
Portata Flow rate	20÷50 l/min	20÷70 l/min	35÷90 l/min	75÷300 l/min	200÷1100 l/min
Pressione Pressure	1,0÷12,0 bar	1,0÷12,0 bar	1,0÷12,0 bar	1,0÷12,0 bar	1,0÷12,0 bar
Filettature Threads	3/4" e 1"	3/4" e 1"	1"	1"1/4 - 1"1/2 - 2"	2" e 3"
Parzializzatore Flow control	●	○	●	●	●
Solenoido 24 VAC 24 VAC Solenoid	●	●	●	●	●
Solenoido 9 VDC 9 VDC Solenoid	●	●	●	●	●

PATENTED **MANIFOLD SYSTEM**

Fai prima, fai meglio!

Do it faster, do it better!

ELETTROVALVOLE

ELECTRIC VALVES

Nei primi anni '80 RAIN ha iniziato a produrre elettrovalvole, sviluppando in oltre quattro decenni una vasta gamma di modelli, che coprono tutte le esigenze del mercato del paesaggio e dei tappeti erbosi, dello sport e dell'agricoltura. Oggi le sue elettrovalvole sono state vendute in più di 15 milioni di unità in 82 paesi diversi in tutto il mondo, rendendo RAIN il più grande produttore in Europa. Le elettrovalvole sono il cuore dei sistemi di irrigazione e c'è un'elettrovalvola Rain per ogni applicazione: adatta per le piccole e medie applicazioni residenziali o professionali nel settore paesaggistico e agricolo, dalla bassa portata all'alta portata, dalla bassa pressione all'alta pressione.

In the early 80s RAIN started to produce electric valves, developing in over four decades a wide range of models, covering all the needs in landscape and turf market, sports and agriculture. Nowadays its solenoid valves have been sold in more than 15 million units in 82 different countries worldwide, making RAIN the largest manufacturer in Europe. Electrovalves are the heart of irrigation systems and there's a Rain electrovalves for every application: suitable for small and medium residential or professional landscape and agricultural applications, from Low flow to high flow, from low pressure to high pressure.

FUNZIONI AVANZATE

ADVANCED FUNCTION

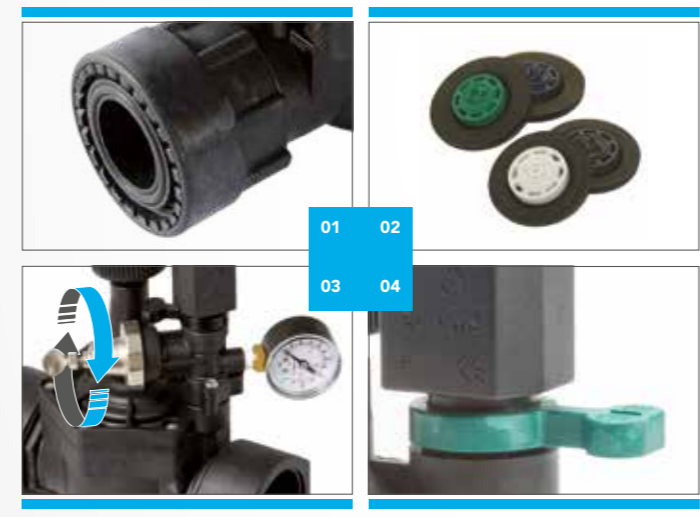

- 01**
ATTACCO UNION
UNION INLET
- 02**
MEMBRANA COSTAMPATA
SINGLE - PIECE DIAPHRAGM
- 03**
REGOLATORE DI PRESSIONE
PRESSURE REGULATOR
- 04**
APERTURA MANUALE
MANUAL OPENING

01 ATTACCO UNION. Lo speciale attacco femmina union consente l'installazione rapida delle elettrovalvole e una comoda manutenzione consentendo la rimozione dell'elettrovalvola dal collettore di partenza dell'impianto.

UNION INLET. The manifold system allows the quick installation of the solenoid valves and a convenient maintenance allowing the removal of the solenoid valve from the starting manifold of the system.

RN 150, JAR-TOP, RN 155, RN 160

02 MEMBRANA COSTAMPATA. La speciale estrusione contemporanea del polipropilene e della TPE conferisce alla membrana una maggior resistenza agli stress elastici di apertura e chiusura dell'elettrovalvola.

SINGLE - PIECE DIAPHRAGM. The special contemporary extrusion of polypropylene and TPE gives the diaphragm greater resistance to the elastic stress of opening and closing solenoid valve.

RN 150, JAR-TOP, RN 155, RN 160

03 REGOLATORE DI PRESSIONE. Tutte le nostre elettrovalvole sono compatibili con il regolatore di pressione Rain. Il regolatore di pressione Rain consente di gestire la pressione in uscita dell'elettrovalvola da un minimo di 1.0 bar ad un massimo di 7 bar.

PRESSURE REGULATOR. All our solenoid valves are compatible with Rain pressure regulator. The Rain pressure regulator allows you to manage the solenoid valve outlet pressure from a minimum of 1.0 bar to a maximum of 7 bar.

RN 150, JAR-TOP, RN 155, RN 160, RN180

04 APERTURA MANUALE. La leva verde ON/OFF posizionata sotto al solenoide consente una facile apertura manuale dell'elettrovalvola.

MANUAL OPENING. The green ON/OFF lever located under the solenoid allows easy manual opening of the solenoid valve.

RN 150, JAR-TOP, RN 155, RN 160, RN180

RN 150

Elettrovalvola
Electric valve

9 VDC **24 VAC**
min 20 l/min max 50 l/min



Condizioni operative	Operating conditions
Pressione: min 1.0 bar - max 12 bar	Pressure: min 1.0 bar - max 12.0 bar
Temperatura: min +4°C - max 70°C	Temperature: +4°C - 70°C
Portata: min 20 l/min - max 50 l/min	Flow rate: from 20 l/min to 50 l/min
Fibra vetro PA 6 30%	PA 6 30% fiberglass
Membrana in parti co-stampata per una miglior tenuta in chiusura	Single-piece diaphragm for reliable leak-free valve closing
Astina in acciaio autopulente	Self cleaning stainless-steel metering pin
Molla della membrana in acciaio con azione progressiva	Stainless-steel diaphragm differential spring for smooth closing
PN12 testato pezzo per pezzo a 14 bar	PN12 tested piece by piece at 14 bar
Apertura manuale laterale	Bleed handle for manual opening with internal bleed

	Perdite di carico / Loss of charge in bar		
	1/2"	3/4"	1"
20 l/min	0.35	0.35	0.30
30 l/min	0.52	0.52	0.45
40 l/min	0.70	0.60	0.60
50 l/min	0.80	0.80	0.70
60 l/min	0.80	0.80	0.70
70 l/min	0.85	0.85	0.75
80 l/min	0.95	0.95	0.85
90 l/min	1.05	1.05	0.95

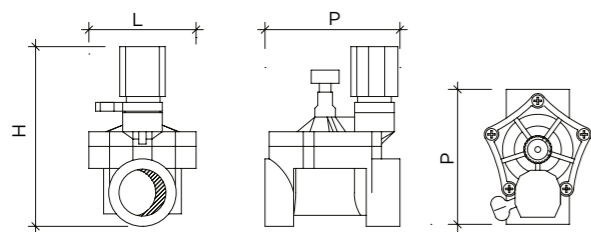

		Dimensioni / Dimensions						in cm
		3/4"M	1"M	1/2"F	3/4"F	1"F	1"MxU	1"UxU
H		11.4	11.4	11.4	11.4	11.4	11.4	11.4
P		11.5	11.6	9.2	9.2	9.2	12.8	14.1
L		7.1	7.1	7.1	7.1	7.1	7.1	7.1

Code	Models
100.4500511	E.V. RN 150 FC 24VAC W/FC - 1/2"F - PRO
100.4500711	E.V. RN 150 FC 24VAC W/FC - 3/4"F - PRO
100.4400711	E.V. RN 150 FC 24VAC W/FC - 3/4"M - PRO
100.4500911	E.V. RN 150 FC 24VAC W/FC - 1"F - PRO
100.4400911	E.V. RN 150 FC 24VAC W/FC - 1"M - PRO
100.4400915	E.V. RN 150 FC 24VAC W/FC - 1"M X UN. - PRO

Code	Models
100.4400916	E.V. RN 150 FC 24VAC W/FC - 1" UN. X UN. - PRO
164.4500711	E.V. RN 150 FC 9VDC (AMP) W/FC - 3/4"F - PRO
164.4500911	E.V. RN 150 FC 9VDC (AMP) W/FC - 1"F - PRO
164.4400915	E.V. RN 150 FC 9VDC (AMP) W/FC - 1"M X UN. - PRO
164.4570911	E.V. RN 150 FC 9VDC (NO AMP) W/FC - 1"F - PRO
103.1503000	MEMBRANA / DIAPHRAGM RN 150 IBCPN

JAR TOP

Elettrovalvola
Electric valve

9 VDC **24 VAC**
min 20 l/min max 70 l/min



Condizioni operative	Operating conditions
Pressione: min 1.0 bar - max 12.0 bar	Pressure: min 1.0 bar - max 12.0 bar
Temperatura: min +4°C - max 70°C	Temperature: min +4°C - max 70°C
Portata: min 20 l/min - max 70 l/min	Flow rate: from 20 l/min to 70 l/min
Fibra vetro PA 6 30%	PA 6 30% fiberglass
Membrana in parti co-stampata per una miglior tenuta in chiusura	Single-piece diaphragm for reliable leak-free valve closing
Astina in acciaio autopulente	Self cleaning stainless-steel metering pin
Molla della membrana in acciaio con azione progressiva	Stainless-steel diaphragm differential spring for smooth closing
PN12 testato pezzo per pezzo a 14 bar	PN12 tested piece by piece at 14 bar
Apertura manuale laterale	Bleed handle for manual opening with internal bleed

	Perdite di carico / Loss of charge in bar		
	3/4"	1"	1" MxU
30 l/min	0.38	0.28	0.33
45 l/min	0.38	0.30	0.34
60 l/min	0.40	0.30	0.35
75 l/min	0.40	0.35	0.35
90 l/min	0.46	0.40	0.40
105 l/min	0.52	0.40	0.45
120 l/min	0.62	0.50	0.56
135 l/min	0.71	0.60	0.65

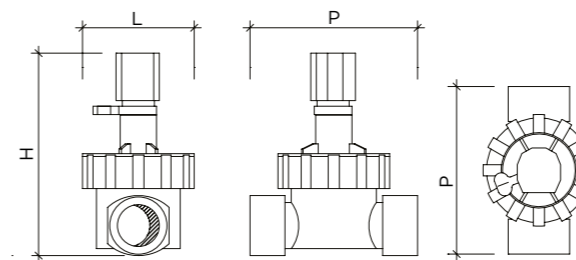

		Dimensioni / Dimensions in cm				
		3/4"M	1"M	3/4"F	1"F	1"MxU
H		14.0	14.0	14.0	14.0	14.0
P		11.6	12.1	12.0	12.0	13.0
L		8.0	8.0	8.0	8.0	8.0

Code	Models
100.3000710	E.V. JAR-TOP 24VAC - 3/4"M - PRO
100.3200710	E.V. JAR-TOP 24VAC - 3/4"F - PRO
100.3000910	E.V. JAR-TOP 24VAC - 1"M - PRO
100.3200910	E.V. JAR-TOP 24VAC - 1"F - PRO

Code	Models
100.3000915	E.V. JAR-TOP 24VAC - 1"MxUN - PRO
164.3000910	E.V. JAR-TOP 9VDC (AMP) - 1"M - PRO
164.3200910	E.V. JAR-TOP 9VDC (AMP) - 1"F - PRO
103.1303000	MEMBRANA RN JAR TOP

RN 155 PLUS

Elettrovalvola
Electric valve

9 VDC **24 VAC** min 30 l/min max 90 l/min



Condizioni operative	Operating conditions
Pressione: min 1.0 bar - max 12 bar	Pressure: min 1.0 bar - max 12.0 bar
Temperatura: min +4°C - max 70°C	Temperature: +4°C - 70°C
Portata: min 30 l/min - max 90 l/min	Flow rate: from 30 l/min to 90 l/min
Fibra vetro PA 6 30%	PA 6 30% fiberglass
Membrana in parti co-stampata per una miglior tenuta in chiusura	Single-piece diaphragm for reliable leak-free valve closing
Astina in acciaio autopulente	Self cleaning stainless-steel metering pin
Molla della membrana in acciaio con azione progressiva	Stainless-steel diaphragm differential spring for smooth closing
PN12 testato pezzo per pezzo a 14 bar	PN12 tested piece by piece at 14 bar
Apertura manuale laterale	Bleed handle for manual opening with internal bleed

Perdite di carico / Loss of charge in bar	3/4"			1"	1" MxU
	30 l/min	0.30	0.25	0.35	
45 l/min	0.30	0.25	0.35		
60 l/min	0.30	0.25	0.35		
75 l/min	0.30	0.25	0.35		
90 l/min	0.37	0.28	0.42		
105 l/min	0.42	0.32	0.47		
120 l/min	0.52	0.35	0.57		
135 l/min	0.62	0.40	0.67		
150 l/min	0.75	0.47	0.80		

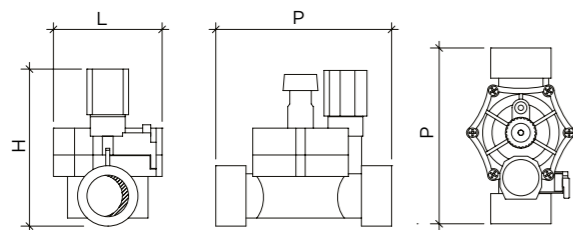

Dimensioni / Dimensions in cm	3/4"M	1"M	1"F	1"MxU
	H	11.5	11.5	11.5
P	13.1	13.1	13.1	13.9
L	8.1	8.1	8.1	8.1

Code	Models
100.1560711	E.V.RN 155 PLUS FC 24VAC - 3/4"M - PRO
100.1580911	E.V.RN 155 PLUS FC 24VAC - 1"F - PRO
100.1560911	E.V.RN 155 PLUS FC 24VAC - 1"M - PRO
100.1560916	E.V.RN 155 PLUS FC 24VAC - 1"M x UN. - PRO
100.1588911	E.V.RN 155 PLUS 24VAC - 1"F WITH PRESSURE REGULATOR - PRO

Code	Models
164.1560711	E.V.RN 155 PLUS FC 9VDC (AMP) - 3/4"M - PRO
164.1580911	E.V.RN 155 PLUS FC 9VDC (AMP) - 1"F - PRO
164.1560911	E.V.RN 155 PLUS FC 9VDC (AMP) - 1"M - PRO
164.1560916	E.V.RN 155 PLUS FC 9VDC (AMP) - 1"M x UN. - PRO
164.1588911	E.V.RN 155 PLUS FC 9VDC (AMP) - 1"F WITH PRESSURE REGULATOR - PRO
103.1563000	MEMBRANA RN 155 PLUS

RN 160 PLUS

Elettrovalvola
Electric valve

9 VDC **24 VAC** min 75 l/min max 325 l/min



Condizioni operative	Operating conditions
Pressione: min 1.0 bar - max 12.0 bar	Pressure: min 1.0 bar - max 12.0 bar
Temperatura: min +4°C - max 70°C	Temperature: min +4°C - max 70°C
Portata: min 75 l/min - max 325 l/min	Flow rate: from 75 l/min to 325 l/min
Fibra vetro PA 6 30%	PA 6 30% fiberglass
Membrana in parti co-stampata per una miglior tenuta in chiusura	Single-piece diaphragm for reliable leak-free valve closing
Astina in acciaio autopulente	Self cleaning stainless-steel metering pin
Molla della membrana in acciaio con azione progressiva	Stainless-steel diaphragm differential spring for smooth closing
PN12 testato pezzo per pezzo a 14 bar	PN12 tested piece by piece at 14 bar
Apertura manuale laterale	Bleed handle for manual opening with internal bleed

Perdite di carico / Loss of charge in bar	1"				1"1/4	1"1/2	2"
	75 l/min	0.20	0.20				
100 l/min	0.27	0.20	0.20	0.16			
125 l/min	0.32	0.21	0.20	0.16			
150 l/min	0.42	0.27	0.20	0.16			
175 l/min	0.58	0.30	0.21	0.18			
200 l/min	0.75	0.40	0.25	0.21			
225 l/min		0.48	0.29	0.23			
250 l/min		0.58	0.34	0.28			
275 l/min		0.69	0.39	0.32			
300 l/min			0.45	0.38			
325 l/min				0.41			

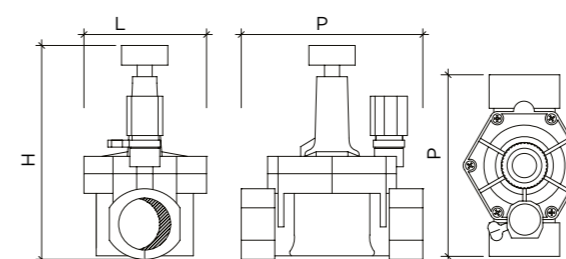

Dimensioni / Dimensions in cm	1"F	1"1/4 F	1"1/2 F	2"F	2"MxU
	H	18.4	18.4	18.4	18.4
P	14.5	14.8	15.7	18.3	17.5
L	10.6	10.6	10.6	10.6	10.6

Code	Models
100.5700911	E.V.RN 160 PLUS FC 24VAC - 1"F - PRO
100.5701211	E.V.RN 160 PLUS FC 24VAC - 1"1/4 F - PRO
100.5701511	E.V.RN 160 PLUS FC 24VAC - 1"1/2 F - PRO
100.5701512	E.V.RN 160 PLUS FC 24VAC - 1"1/2 F - PRO (CON BC)
100.5781511	E.V.RN 160 PLUS 24VAC - 1"1/2 F WITH PRESSURE REGULATOR - PRO
100.5701516	E.V.RN 160 PLUS FC 24VAC - 1"1/2 M X UN. - PRO
100.5701711	E.V.RN 160 PLUS FC 24VAC - 2"F - PRO
100.5701712	E.V.RN 160 PLUS FC 24VAC - 2"F - PRO (CON BC)

Code	Models
100.5701716	E.V.RN 160 PLUS FC 24VAC - 2"M X UN. - PRO
164.5701516	E.V.RN 160 PLUS FC 9VDC (AMP) - 1"1/2 M X UN. - PRO
164.5701711	E.V.RN 160 PLUS FC 9VDC (AMP) - 2"F - PRO
164.5701716	E.V.RN 160 PLUS FC 9VDC (AMP) - 2"M X UN. - PRO
164.5701511	E.V.RN 160 PLUS FC 9VDC (AMP) - 1"1/2 F - PRO
164.5781511	E.V.RN 160 PLUS 9VDC (AMP) - 1"1/2 F WITH PRESSURE REGULATOR - PRO
164.5771511	E.V.RN 160 PLUS FC 9VDC (NO AMP) - 1"1/2 F - PRO
103.1603000	MEMBRANA RN 160 PLUS

RN 180

Elettrovalvola
Electric valve



9 VDC **24 VAC**
min 200 l/min max 1100 l/min



Condizioni operative	Operating conditions
Pressione: min 1.0 bar - max 12 bar	Pressure: min 1.0 bar - max 12.0 bar
Temperatura: min +4°C - max 70°C	Temperature: +4°C - 70°C
Portata: min 200 l/min - max 1100 l/min	Flow rate: from 200 l/min to 1100 l/min
Fibra vetro PA 6 30%	PA 6 30% fiberglass
Membrana in parti co-stampata per una miglior tenuta in chiusura	Single-piece diaphragm for reliable leak-free valve closing
Astina in acciaio autopulente	Self cleaning stainless-steel metering pin
Molla della membrana in acciaio con azione progressiva	Stainless-steel diaphragm differential spring for smooth closing
PN12 testato pezzo per pezzo a 14 bar	PN12 tested piece by piece at 14 bar
Apertura manuale laterale	Bleed handle for manual opening with internal bleed

	Perdite di carico / Loss of charge in bar	
	2"	3"
200 l/min	0.07	0.05
300 l/min	0.09	0.07
400 l/min	0.12	0.09
500 l/min	0.14	0.12
600 l/min	0.16	0.14
700 l/min	0.19	0.16
800 l/min	0.25	0.18
900 l/min	0.31	0.23
1000 l/min	0.38	0.28
1100 l/min	0.47	0.35

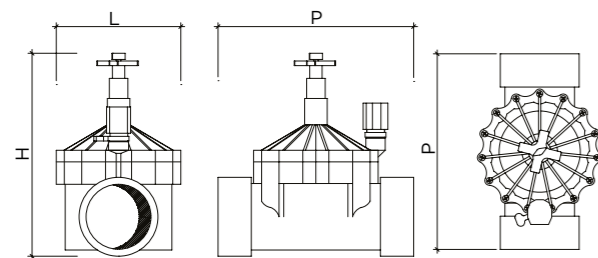

	Dimensioni / Dimensions in cm		
	3"M	3"F	2"F
H	25.0	25.0	25.0
P	24.0	25.3	25.3
L	17.0	17.0	17.0

Code	Models
100.1802510	E.V.RN 180 FC 24VAC - 2" F - PRO
100.1882510	E.V.RN 180 FC 24VAC - 2" F WITH PRESSURE REGULATOR - PRO
100.1803410	E.V.RN 180 FC 24VAC - 3" F - PRO
100.1883410	E.V.RN 180 FC 24VAC - 3" F WITH PRESSURE REGULATOR - PRO
100.1803510	E.V.RN 180 FC 24VAC - 3" M - PRO

Code	Models
164.1802510	E.V.RN 180 FC 9VDC (AMP) - 2" F - PRO
164.1882510	E.V.RN 180 FC 9VDC (AMP) - 2" F WITH PRESSURE REGULATOR - PRO
164.1883410	E.V.RN 180 FC 9VDC (AMP) - 3" F WITH PRESSURE REGULATOR - PRO
164.1803410	E.V.RN 180 FC 9VDC (AMP) - 3" F - PRO
164.1803510	E.V.RN 180 FC 9VDC (AMP) - 3" M - PRO
103.1803000	MEMBRANA RN 180 IBN

SOLENOIDS

Solenoid
Solenoid

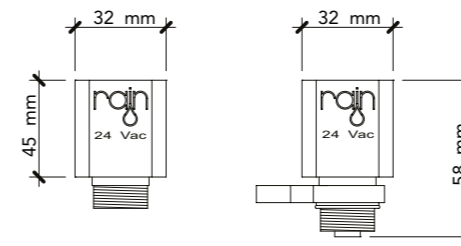

9 VDC **24 VAC**



Condizioni operative	Operating conditions
Pressione: min 1.0 bar - max 12.0 bar	Pressure: min 1.0 bar - max 12.0 bar
Temperatura: min +4°C - max 70°C	Temperature: min +4°C - max 70°C
Assorbimento solenoide 0.2 amp, 4.8 VA	Energy efficient solenoid 0.2 amp, 4.8 VA

PRESSURE REGULATOR

Regolatore di pressione
Pressure regulator



Condizioni operative	Operating conditions
Pressione: min 1.0 bar - max 7 bar	Pressure: min 1.0 bar - max 7.0 bar
Pressione d'entrata: max 12 bar	Pressure input: max 12 bar
Differenza minima di pressione: 1.0 bar	Mini differential pressure: 1.0 bar
Temperatura: min +4°C - max 70°C	Temperature: min +4°C max 70°C

Code	Models
101.1001101	RN 24 VAC SOLENOID - PRO
101.1006001	RN 12 VAC SOLENOID - PRO
101.1004001	RN 12 VDC SOLENOID - PRO
101.1005001	RN 24 VDC SOLENOID - PRO

9 VDC **24 VAC**



Caratteristiche tecniche	Technical characteristics
Realizzato in nylon e Fibra vetro	Made of nylon-fiberglass and stainless steel
Manometro di lettura	Pressure gauge
Vite di regolazione	Regulation screw
Installabile su tutte le elettrovalvole Rain	It can be installed on all Rain electric valves

Code	Models
101.3507000	RN 9VDC (AMP) LATCHING SOLENOID - PRO
101.3577000	RN 9VDC (NO AMP) LATCHING SOLENOID - PRO
101.4902000	X EV RAIN BIRD ADAPTOR - PRO
120.8000100	REGOLATORE DI PRESSIONE/ ADJUSTABLE PRESSURE REGULATOR





POZZETTI

VALVE BOXES

Tra i tanti brevetti di Rain troviamo anche il sistema EZ-Open dei pozzetti, un'idea semplice ma che ha cambiato il modo di aprire dei pozzetti per le elettrovalvole. La maniglia integrata nel pozzetto rispecchia al 100% la filosofia di Rain rivolta a semplificare e velocizzare il lavoro dei suoi clienti. Al brevetto EZ-Open si aggiunge il recente brevetto della griglia per pozzetto 113 e 115.

Among Rain's many patents we also find the EZ-Open system of the valve boxes, a simple idea that has changed the way to open valve boxes. The handle integrated in the valve boxes reflects 100% Rain's philosophy of simplifying and speeding up the work of its customers.

In addition to the EZ-Open patent, there is the recently patented RACK for EZ-Open 113 and 115.

FUNZIONI AVANZATE

ADVANCED FUNCTION

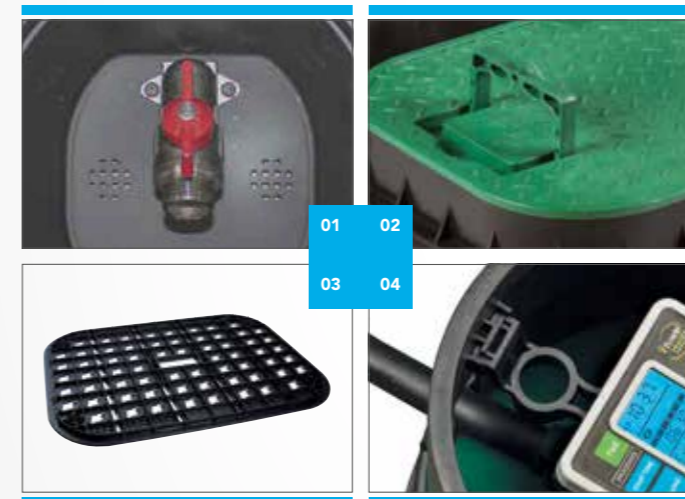

01
VALVOLA INTEGRATA
INTEGRATED VALVE

02
EZOPEN

03
GRIGLIA PER COLLETTORE
RACK FOR EASY OPEN

04
BRACKET

01
VALVOLA INTEGRATA. Valvola 3/4" integrata.

INTEGRATED VALVE. 3/4" integrated valve.

PZCR RN 15

02
EZOPEN. Il sistema brevettato RAIN di apertura EZOPEN consente l'apertura del pozzetto con estrema facilità.

EZOPEN. The patented RAIN EZOPEN opening system makes it extremely easy to open the valve box.

PZCM15, PZCM25, PZRM113, PZRM115, PZRM117

03
GRIGLIA PER COLLETTORE. La griglia per collettori RAIN permette la realizzazione dei collettori di partenza con estrema facilità e velocità.

RACK FOR EASY OPEN. The RAIN collector grille allows the construction of the starting collectors with extreme ease and quick.

PZRM113, PZRM115

04
BRACKET. Il gancio integrato sul corpo del pozzetto permette il posizionamento delle centraline IP68 RAIN lontano da terra e acqua.

BRACKET. The integrated hook on the valve box allows the positioning of the IP68 RAIN control units away from the ground and water.

PZCM25, PZRM113, PZRM115, PZRM117

POZZETTI VALVE BOXES	PZCR 15	PZCM 15	PZCM 25	PZRM 113	PZRM 115	PZRM 117
CARATTERISTICHE PRINCIPALI / MAIN FEATURES						
Dimensioni Dimensions		Ø 243 mm Ø 152 mm h=229 mm	Ø 336 mm Ø 253 mm h=261 mm	252x395 mm 275x400 mm h=330 mm	660x495 mm 385x555 mm h=330 mm	810x590 mm 370x590 mm h=415 mm
Rubinetto Tap timer	●	○	○	○	○	○
Attacco centraline IP68 Rain Bracket for IP68 controllers	○	○	●	●	●	●
Griglia Rack	○	○	○	●	●	○
Maniglia Handle	●	●	●	●	●	●

OVAL VALVE BOX WITH 3/4" BALL VALVE

Pozzetto
Valve box



Versioni disponibili / Available versions

Black body - Green lid

Caratteristiche tecniche

Materiale: 100% polipropilene	Material: 100% polypropylene
Materiale valvola: lega di zinco	Valve material: zinc alloy
Valvola 3/4" maschio filettata	Valve 3/4" male thread
Ingresso 3/4" femmina filettata	Inlet 3/4" female thread
Coperchio robusto	High resistance lid
Dimensioni: 220hx200x120 mm	Dimensions: 220hx200x120mm
Sportello ingresso tubo dell'acqua, con chiusura di sicurezza, integrato nel coperchio	Flip cover with security clips integrated in the lid

Technical characteristics

Material: 100% polypropylene
Valve material: zinc alloy
Valve 3/4" male thread
Inlet 3/4" female thread
High resistance lid
Dimensions: 220hx200x120mm
Flip cover with security clips integrated in the lid

Code	Models
210.3000101	PZCR RN15 VERDE/NERO (GREEN/BLACK)
125.3000021	GREEN LID

ROUND VALVE BOX 15 "EZOPEN" PAT

Pozzetto
Valve box



PZCM 15

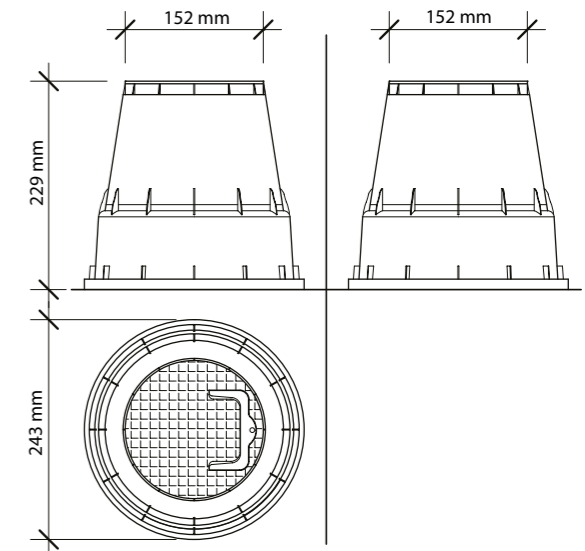

Versioni disponibili / Available versions

Black body - Green lid
Green body - Green lid

Caratteristiche tecniche

Materiale: 100% polipropilene	Material: 100% polypropylene
Maniglia di apertura	Opening handle
Vite di chiusura pozzetto	Valve box closing screw
Apertura con rotazione	Twist - lock lid

Technical characteristics

Material: 100% polypropylene
Opening handle
Valve box closing screw
Twist - lock lid

Code	Models
210.3001150	EZ-OPEN PZCM RN 15 VERDE/NERO (GREEN/BLACK)
210.3002150	EZ-OPEN PZCM RN 15 VERDE/VERDE (GREEN/GREEN)

ROUND VALVE BOX 25 "EZOPEN"^{PAT}

Pozzetto
Valve box



PZCM 25

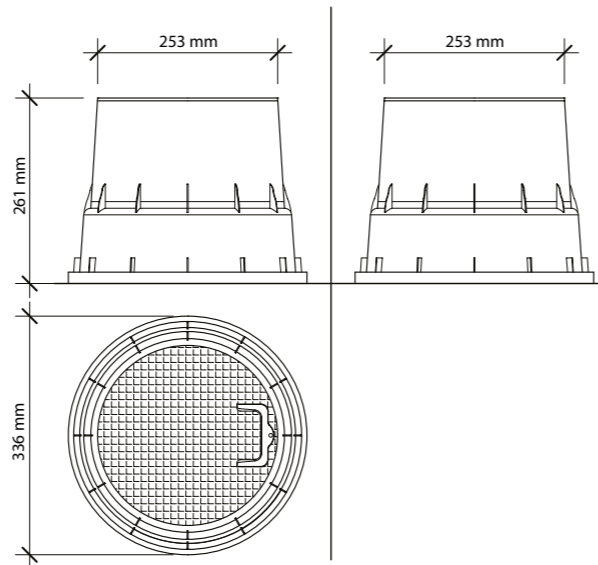

Versioni disponibili / Available versions

Black body - Green lid

Green body - Green lid

Caratteristiche tecniche

Materiale: 100% polipropilene

Maniglia di apertura

Vite di chiusura pozzetto

Apertura con rotazione

Supporto centraline Rain IP68

Technical characteristics

Material: 100% polypropylene

Opening handle

Valve box closing screw

Twist - lock lid

Support for Rain IP68 control units

Code	Models
210.3001250	EZ-OPEN PZCM RN 25 VERDE/NERO (GREEN/BLACK)
210.3002250	EZ-OPEN PZCM RN 25 VERDE/VERDE (GREEN/GREEN)

RECTANGULAR VALVE BOX 113 "EZOPEN"^{PAT}

Pozzetto
Valve box

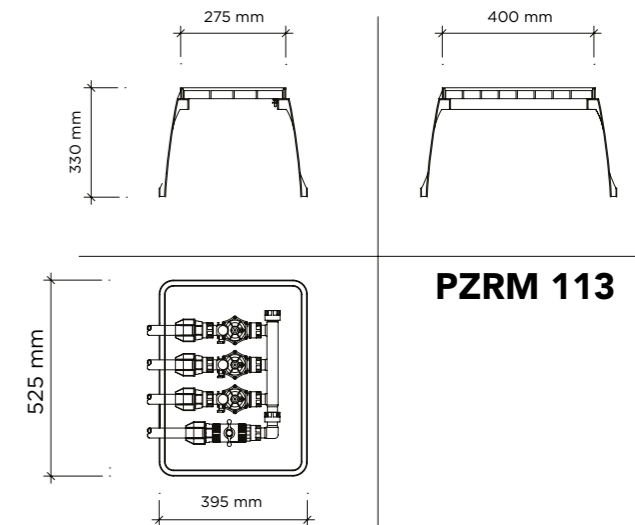

PZRM 113

Versioni disponibili / Available versions

Black body - Green lid

Green body - Green lid

Caratteristiche tecniche

Materiale: 100% polipropilene

Maniglia di apertura

UNI EN 124 A class A 15 (Peak load >15 Kn)

Vite di chiusura pozzetto

Supporto centraline Rain IP68

Technical characteristics

Material: 100% polypropylene

Opening handle

UNI EN 124 A class A 15 (Peak load >15 Kn)

Valve box closing screw

Support for Rain IP68 control units

Code	Models
210.3001113	EZ-OPEN PZRM 113 VERDE/NERO (GREEN/BLACK)
210.3002113	EZ-OPEN PZRM 113 VERDE/VERDE (GREEN/GREEN)

RECTANGULAR VALVE BOX 115 "EZOPEN"^{PAT}

Pozzetto
Valve box

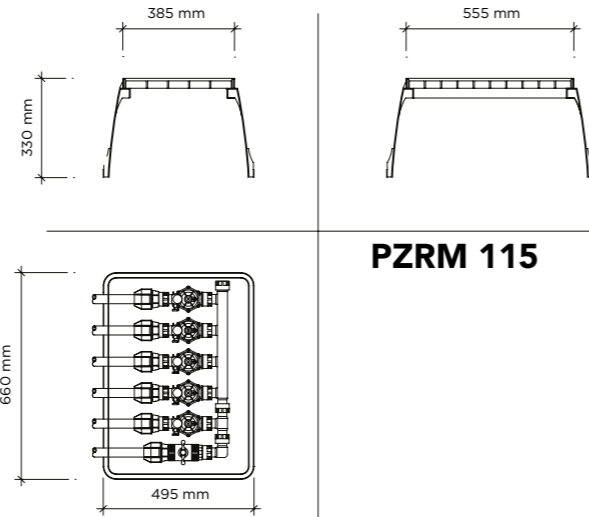

PZRM 115

Versioni disponibili / Available versions

- Black body - Green lid
- Green body - Green lid

Caratteristiche tecniche

- Materiale: 100% polipropilene
- Maniglia di apertura
- UNI EN 124 A class A 15 (Peak load >15 Kn)
- Vite di chiusura pozzetto

Technical characteristics

- Material: 100% polypropylene
- Opening handle
- UNI EN 124 A class A 15 (Peak load >15 Kn)
- Valve box closing screw

Code	Models
210.3001115	EZ-OPEN PZRM 115 VERDE/NERO (GREEN/BLACK)
210.3002115	EZ-OPEN PZRM 115 VERDE/VERDE (GREEN/GREEN)

RECTANGULAR VALVE BOX 117 "EZOPEN"^{PAT}

Pozzetto
Valve box

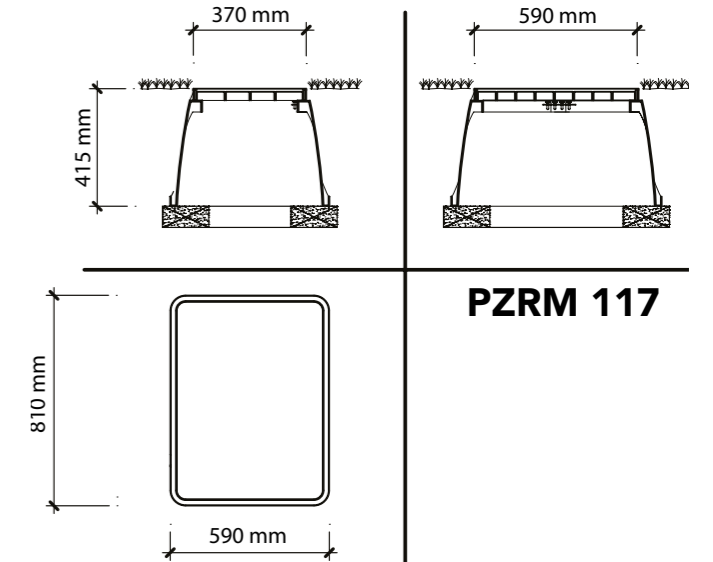

PZRM 117

Versioni disponibili / Available versions

- Black body - Green lid
- Green body - Green lid

Caratteristiche tecniche

- Materiale: 100% polipropilene
- Maniglia di apertura
- UNI EN 124 A class A 15 (Peak load >15 Kn)
- Vite di chiusura pozzetto

Technical characteristics

- Material: 100% polypropylene
- Opening handle
- UNI EN 124 A class A 15 (Peak load >15 Kn)
- Valve box closing screw

Code	Models
210.3001117	EZ-OPEN PZRM 117 VERDE/NERO (GREEN/BLACK)

VALVE BOX RACK FOR "EZOPEN 113" PAT

Griglia per pozzetto
Valve box rack

9 VDC **24** VAC 

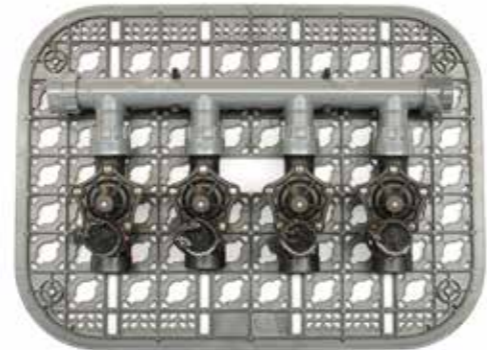

Versioni disponibili	Available versions
Griglia + 4 ganci da 1"	Rack with 4 1" hooks
Ganci da 1" 1/2	1 1/2" hooks
Ganci da 2"	2" hooks
preassemblata con manifold e 4 elettrovalvole	pre-assembled with manifold and 4 solenoid valves

Caratteristiche tecniche	Technical characteristics
Facile installazione su pareti di locali tecnici	Easy installation on walls of technical rooms
il suo design speciale aiuta a mantenere ordinato e pulito il pozzetto per semplificare la manutenzione dell'impianto di irrigazione	its special design helps to keep orderly and clean the valve box to simplify the maintenance of the irrigation system
I ganci del manifold consentono una facile installazione nel pozzetto	The manifold hooks allow an easy installation in the valve box
Compatibile con i pozzetti rettangolari standard (PZRM113)	Compatible with standard rectangular valve box (PZRM113)

Code	Models
100.4151130	KIT 4 EV 150 M/UN 24VAC
164.4151130	KIT 4 EV 150 M/UN 9VDC
100.1561130	KIT 4 EV 155 M/UN 24VAC
164.1561130	KIT 4 EV 155 M/UN 9VDC
125.8000500	GRIGLIA PER PZ113 + 4 GANCI 1" / RACK FOR PZ113 + 1" HANGER (4 pcs)

Code	Models
210.9901113	8 GANCI 1" / 1" HANGER FOR RACK (8 pcs)
210.9901112	8 GANCI 1"1/2 / 1"1/2 HANGER FOR RACK (8 pcs)
210.9901120	8 GANCI 2" / 2" HANGER FOR RACK (8 pcs)

VALVE BOX RACK FOR "EZOPEN 115" PAT

Griglia per pozzetto
Valve box rack

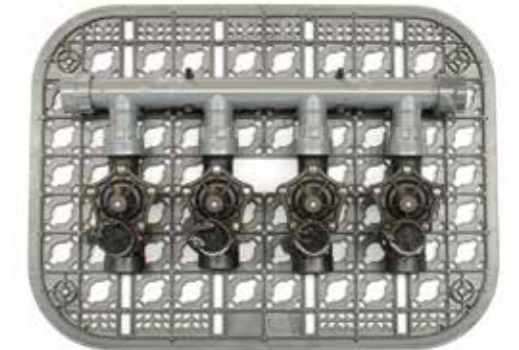

Versioni disponibili	Available versions
Griglia + 4 ganci da 1"	Rack with 4 1" hooks
Ganci da 1" 1/2	1 1/2" hooks
Ganci da 2"	2" hooks

Caratteristiche tecniche	Technical characteristics
Facile installazione su pareti di locali tecnici	Easy installation on walls of technical rooms
il suo design speciale aiuta a mantenere ordinato e pulito il pozzetto per semplificare la manutenzione dell'impianto di irrigazione	its special design helps to keep orderly and clean the valve box to simplify the maintenance of the irrigation system
I ganci del manifold consentono una facile installazione nel pozzetto	The manifold hooks allow an easy installation in the valve box
Compatibile con i pozzetti rettangolari standard (PZRM115)	Compatible with standard rectangular valve box (PZRM115)

Code	Models
125.8000600	GRIGLIA PER PZ115 + 4 GANCI 1" / RACK FOR PZ115 + 1" HANGER (4 pcs)
210.9901113	8 GANCI 1" / 1" HANGER FOR RACK (8 pcs)
210.9901112	8 GANCI 1"1/2 / 1"1/2 HANGER FOR RACK (8 pcs)
210.9901120	8 GANCI 2" / 2" HANGER FOR RACK (8 pcs)



RACCORDI

FITTINGS

Ad oggi più di 15 linee di prodotti innovativi sono state sviluppate e brevettate, tra tutte troviamo anche Manifold System: una gamma completa di elettrovalvole e collettori per una facile installazione e manutenzione senza paragoni.

To date more than 15 lines of innovative products have been developed and patented, amongst all of these we could find the Manifold System: a complete range of solenoid valves and manifolds for a easy installation and a maintenance with no comparison.



**Fai prima,
fai meglio!**

Do it faster,
do it better!



MANIFOLD SYSTEM

PVC MANIFOLD MULTI PORTS 1"

Raccordo
Fitting



Caratteristiche tecniche	Technical characteristics
Realizzato in PVC	Made of PVC
PN12	PN12
Assemblaggio completamente automatico	Completely automatic assembling
impacchettato in busta di plastica (una per ogni pezzo)	Packed in plastic bags of 1 piece each
BSP	BSP
Con codice a barre	with barcode

MANIFOLD 2 PORTS

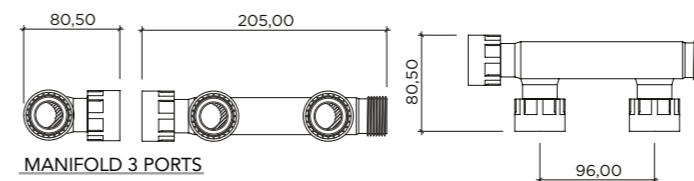

MANIFOLD 3 PORTS

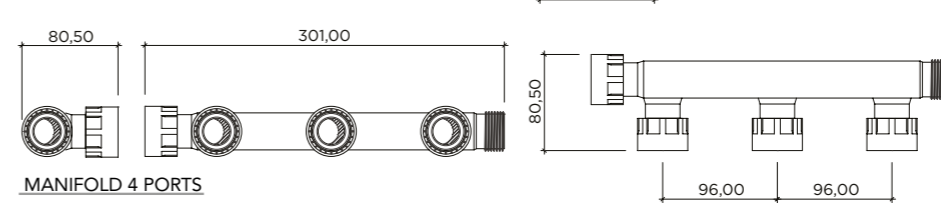

MANIFOLD 4 PORTS

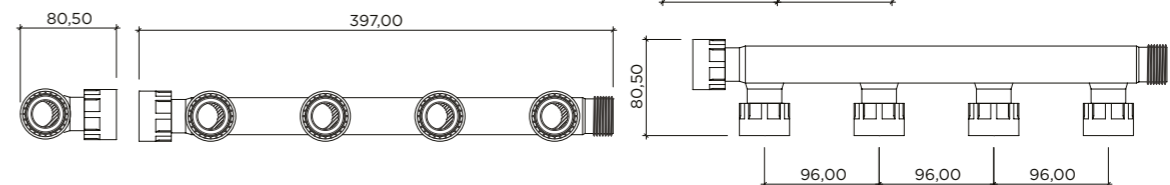

Code	Models
145.2000000	MANIFOLD SYSTEM 2 PORTS 1": Ghiera (Swivel) x M x Ghiera (Swivel) (2)
145.3000000	MANIFOLD SYSTEM 3 PORTS 1": Ghiera (Swivel) x M x Ghiera (Swivel) (3)
145.4000000	MANIFOLD SYSTEM 4 PORTS 1": Ghiera (Swivel) x M x Ghiera (Swivel) (4)
145.1000000	CALOTTA PER COLLETTORI / CAP 1"

PVC MANIFOLD 1"

Famiglia di raccordi
Family of fittings



Caratteristiche tecniche	Technical characteristics
Realizzato in PVC	Made of PVC
PN12	PN12
Assemblaggio completamente automatico	Completely automatic assembling
impacchettato in busta di plastica (una per ogni pezzo)	Packed in plastic bags of 1 piece each
BSP	BSP

TEE FxFxM 1"

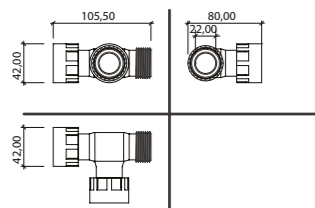

ELBOW FxF 1"

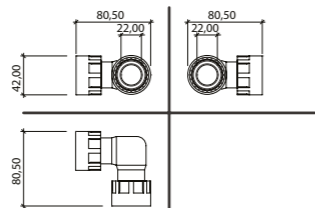

ADAPTOR FxM 1"

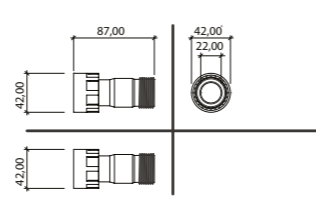

CROSS FxFxFxM 1"

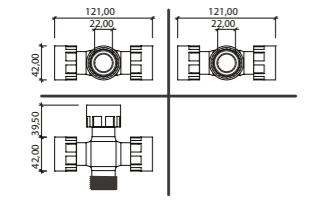

ELBOW FxM 1"

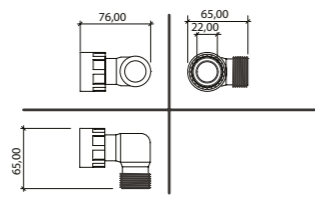

COUPLING FxF 1"

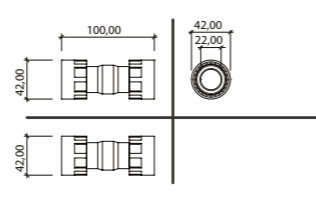

CROSS FxFxFxF 1"

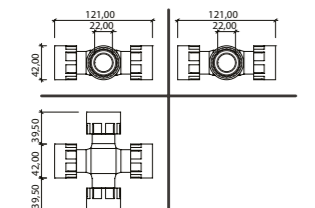

NIPPLE 1"

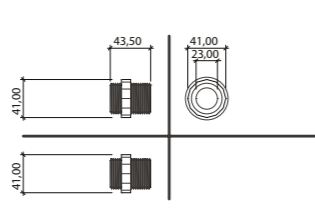

NIPPLE 1" x 3/4"

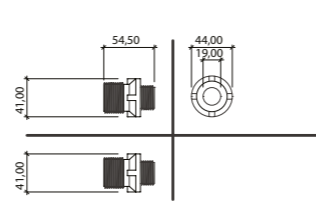

Code	Models
145.1100000	TEE FxFxM 1"
145.8100000	CROSS FxFxFxM 1"
145.8000000	CROSS FxFxFxF 1"
145.7000000	ELBOW FxF 1"
145.7100000	ELBOW FxM 1"

Code	Models
600.5002015	NIPPLE 1"
145.6100000	ADAPTOR FxM 1"
145.6000000	COUPLING FxF 1"
600.5002020	NIPPLE 1" x 3/4"

PVC MANIFOLD 1"1/2 & 2"

Famiglia di raccordi
Family of fittings



Caratteristiche tecniche	Technical characteristics
Realizzato in PVC	Made of PVC
PN12	PN12
Assemblaggio completamente automatico	Completely automatic assembling
impacchettato in busta di plastica (una per ogni pezzo)	Packed in plastic bags of 1 piece each
BSP	BSP

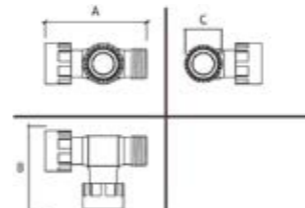

TEE FxFxM - DIMENSIONS (in cm)		
	1" 1/2	2"
A	16	18
B	10	11
C	6	7

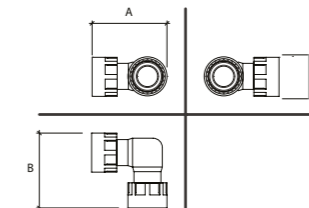

ELBOW FxF - DIMENSIONS (in cm)		
	1" 1/2	2"
A	10.5	11.5
B	10.5	11.5
C	6	7

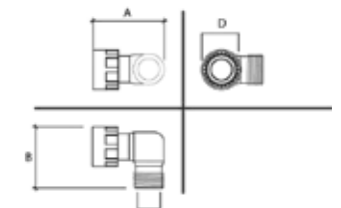

ELBOW FxM - DIMENSIONS (in cm)		
	1" 1/2	2"
A	10.5	12
B	10.5	12
C	4.5	6
D	6	7

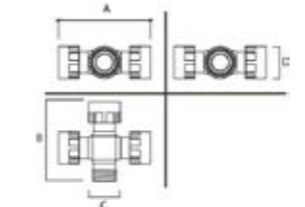

CROSS FxFxM - DIMENSIONS (in cm)		
	1" 1/2	2"
A	16	18
B	16	18
C	4.5	6
D	6	7

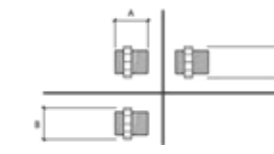

NIPPLE - DIMENSIONS (in cm)			
	1" 1/2	1"1/2 x 1"	1"1/2 x 1" 1/4"
A	5.5	5.5	5.5
B	5	3	4
C	5	5	5

Code	Models
146.1100000	TEE FxFxM 1"1/2
147.1100000	TEE FxFxM 2"
146.8100000	CROSS FxFxFxM 1"1/2
147.8100000	CROSS FxFxFxM 2"
146.7000000	ELBOW FxF 1"1/2
147.7000000	ELBOW FxF 2"

Code	Models
146.7100000	ELBOW FxM 1"1/2
147.7100000	ELBOW FxM 2"
146.9000112	NIPPLE 1"1/2
146.9000100	NIPPLE 1"1/2 x 1"
146.9000114	NIPPLE 1"1/2 x 1"1/4"

P.P. FITTINGS WITH BARCODE

Raccordo
Fitting



Caratteristiche tecniche	Technical characteristics
Realizzato in PVC	Made of PP
PN12	PN10
Assemblaggio completamente automatico	Completely automatic assembling
Con codice a barre	with barcode

BUSHING MF W/OR



REDUCTION NIPPLE W/OR



ELBOW 90 F W/OR



NIPPLE W/OR



COUPLER W/OR



TEE F W/OR



Code	Models
610.8103412	BUSHING MF 3/4"x1/2" W/OR
610.8103400	BUSHING MF 1"x3/4 W/OR
610.1201200	NIPPLE 1/2" W/OR
610.1203400	NIPPLE 3/4" W/OR
610.1201000	NIPPLE 1" W/OR
610.1103412	REDUCTION NIPPLE 3/4"x1/2" W/OR
610.1103400	REDUCTION NIPPLE 1"x3/4" W/OR
610.2201200	COUPLER 1/2" W/OR
610.2203400	COUPLER 3/4" W/OR

Code	Models
610.2103412	REDUCTION COUPLER 3/4"x1/2" W/OR
610.2103400	REDUCTION COUPLER 1"x3/4" W/OR
610.3201200	ELBOW 90 1/2" F W/OR
610.3203400	ELBOW 90 3/4" F W/OR
610.3201000	ELBOW 90 1" F W/OR
610.4201200	TEE 1/2" F W/OR
610.4203400	TEE 3/4" F W/OR
610.4201000	TEE 1" F W/OR

BALL VALVE

Valvola a sfera
Ball valve



Caratteristiche tecniche	Technical characteristics
Realizzato in PVC	Made of PVC
PN12	PN12
Assemblaggio completamente automatico	Completely automatic assembling
impacchettato in busta di plastica (una per ogni pezzo)	Packed in plastic bags of 1 piece each
BSP	BSP

CLAMP SADDLES

Prese a staffa
Clamp saddles



Caratteristiche tecniche	Technical characteristics
Realizzato in polipropilene	Material: black polypropylene
Guarnizione: gomma nitrilica	Gasket: nitrilic rubber 70 shore
Vite: acciaio zincato	Screw: galvanized steel
Anello di rinforzo: acciaio inossidabile "AISI 430"	Reinforcing ring: stainless steel "AISI 430"
Max pressione: 6 bar	Admissible pressure: 6 bar
Filettatura: conforme alla norma europea UNI 228	Threading: in compliance to the European Standard UNI 228
Applicazioni: industria, acquedotti, giardinaggio	Applications: industry, aqueducts, gardening
Versioni: da 20 x 1/2" a 63 x 1 1/2"	Versions: 20 x 1/2" to 63 x 1 1/2"

Code	Models
143.1000915	VALVOLA A SFERA (BALL VALVE) 1" M x UN
600.6002534	PRESA A STAFFA 1 BULLONE (CLAMP SADDLE 1 BOLT) D.25x3/4"
600.6003234	PRESA A STAFFA 1 BULLONE (CLAMP SADDLE 1 BOLT) D.32x3/4"
600.5102012	PRESA A STAFFA 2 BULLONI (CLAMP SADDLE 2 BOLTS) D.20x1/2"
600.5102512	PRESA A STAFFA 2 BULLONI (CLAMP SADDLE 2 BOLTS) D.25x1/2"
600.5102534	PRESA A STAFFA 2 BULLONI (CLAMP SADDLE 2 BOLTS) D.25x3/4"

Code	Models
600.5103212	PRESA A STAFFA 2 BULLONI (CLAMP SADDLE 2 BOLTS) D.32x1/2"
600.5103234	PRESA A STAFFA 2 BULLONI (CLAMP SADDLE 2 BOLTS) D.32x3/4"



IRRIGATORI

SPRINKLERS

Da sempre Rain cerca di portare innovazioni e soluzioni per una migliore gestione delle risorse. Anche nel mercato degli irrigatori Rain introduce la tecnologia IFT (Intelligent Flow Technology) che permette la riduzione della gittata senza interferire sulla precipitazione e il brevettato sistema di regolazione dell'angolo di lavoro "Arc Set Degree". Le tecnologie IFT e ASD sono in grado di far risparmiare fino al 75% del tempo agli installatori.

Rain has always sought to bring innovations and solutions for a better management of resources. In fact the company has introduced, in the sprinkler market, the IFT technology (Intelligent Flow Technology) that allows the reduction of the radius without interfering with the precipitation and the patented "Arc Set Degree" working angle adjustment system. IFT and ASD technologies can save up to 75% of installers' time.

FUNZIONI AVANZATE ADVANCED FUNCTION

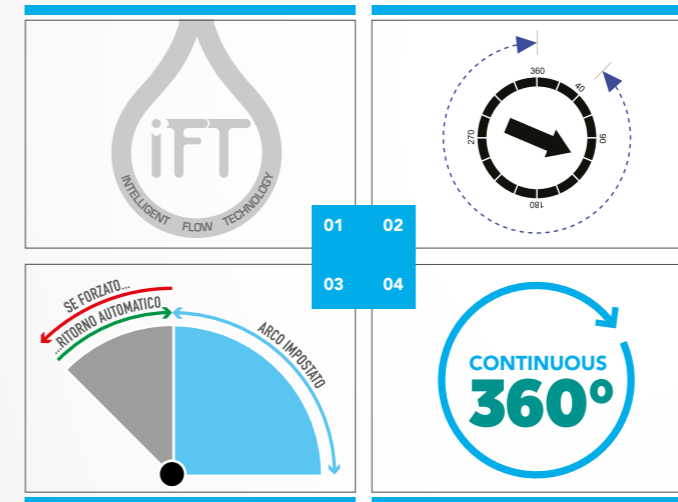

01
INTELLIGENT FLOW TECHNOLOGY

02
ARC SET DEGREE

03
ARC MEMORY CLUTCH

04
360° CONTINUO
CONTINUOUS 360°

01
INTELLIGENT FLOW TECHNOLOGY. Il dispositivo IFT consente la regolazione della gittata agendo su una membrana interna riducendo la gittata lasciando inalterate le proprietà di precipitazione dell'ugello.

INTELLIGENT FLOW TECHNOLOGY. The IFT device allows the range adjustment by acting on an internal membrane reducing the range while leaving the precipitation properties of the nozzle unchanged.

S075D, S075S

02
ARC SET DEGREE. La visualizzazione dell'angolo di lavoro impostato consente un risparmio fino al 75% di tempo per la regolazione dell'angolo di lavoro.

ARC SET DEGREE. The Arc Set Degree saves up to 75% time for working angle adjustment.

S050S, S075S

03
ARC MEMORY CLUTCH. Impedisce il danneggiamento dell'ingranaggio interno e riporta automaticamente l'angolo di lavoro nella posizione desiderata se la torretta porta ugello viene forzata oltre l'arresto.

Arc Memory Clutch - Prevents internal gear damage and returns rotor to its prior setting automatically if nozzle turret is forced past stop.

S075S, S100

04
360° CONTINUO. L'irrigatore se impostato a 360° continuerà la sua corsa senza invertire il senso di rotazione.

CONTINUOUS 360°. Provides a full range of adjustment from 40° to continuous 360°.

S075S, S100

IRRIGATORI SPRINKLERS	S020	S050	S050 S	S075	S075 D	S075 S	S100
CARATTERISTICHE PRINCIPALI / MAIN FEATURES							
Attacco inlet	1/2"	1/2"	1/2"	3/4"	3/4"	3/4"	1"
Portata Flow rate	1,1+19,0 l/min	2,8+14,4 l/min	2,8+14,4 l/min	2,6+32,6 l/min	3,4+36,7 l/min	4,2+42,0 l/min	19,3+110,5 l/min
Gittata Radius	1,8+5,2 m	5,5+9,0 m	5,5+9,0 m	6,7+15,5 m	7,9+14,3 m	7,9+14,0 m	13,7+21,0 m
Regolazione Arco ASD Arc set degree	○	○	●	○	○	●	●
Regolazione della gittata Radius adjustment	Standard	Standard	Standard	Standard	IFT	IFT	○
Ugelli Angolo basso Low Angle Nozzles	○	○	○	●	●	●	○
Tipo di getto Type of sprinkler	Statico	Dinamico	Dinamico	Dinamico	Dinamico	Dinamico	Dinamico
Alzo Riser Height	5+10 cm	10 cm	10 cm	10 cm	10 cm	10 cm	12,7 cm

S020

Irrigatore statico
1/2" Sprays

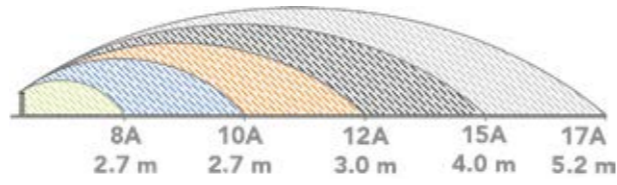

Caratteristiche e vantaggi

Alzo 5 cm e 10 cm
Irrigatore adatto per tutte le testine femmine
Molla in acciaio Inox - permette il rientro dell'irrigatore in tutte le condizioni
L'irrigatore permette di regolare l'orientamento del getto ruotando l'alzo
Ghiera costampata - garantisce il funzionamento dell'irrigatore anche con basse pressioni
Codice colore per le testine

Features and benefits

Riser Height: 5 and 10 cm
Accepts Female Threaded Nozzles
Stainless Steel Retraction Spring - Provides reliable retraction of the riser in all soil conditions
Ratcheting Riser - Allows for easy pattern alignment by turning the riser
Co-Molded Wiper Seal Ensures leak free, full pop-up operation even under low-pressure situations
Color code nozzle

Caratteristiche tecniche

- Pressione di esercizio 1.4 - 3.5 bar
- Portate ugelli da 1.9 l/min a 17.5 l/min
- Attacco 1/2"

Technical characteristics

- Operating pressure: 1.4 - 3.5 bar
- Flow Range: 1.9 - 17.5 l/min
- Inlet: 1/2"

Prestazioni testine fisse femmina Performances Female Threaded Nozzles

PATTERN	NOZZLE	PRESSURE	RADIUS m	FLOW l/min
Center Strip	FN15CS	1.5	1,2 x 7,3	3,0
		2.0	1,2 x 9,1	3,8
Side Strip	FN15SS	1.5	1,2 x 8,5	4,2
		2.0	1,5 x 9,8	4,9
High Low	FN15HL	1.5	4,3x1,2x8,5	2,84
		2.0	4,6x1,5x9,8	3,22

Prestazioni 8A Performances 8A

ARC	PRESSURE	RADIUS m	FLOW l/min
90°	1.38	2,74	1,48
	2.07	3,05	1,59
	2.76	3,05	1,89
	3.45	3,35	2,31
180°	1.38	2,74	2,84
	2.07	2,74	3,22
	2.76	3,05	3,79
	3.45	3,05	4,39
270°	1.38	2,74	4,35
	2.07	2,74	4,73
	2.76	3,05	5,68
	3.45	3,05	6,62
360°	1.38	2,74	5,68
	2.07	2,74	6,44
	2.76	3,05	7,57
	3.45	3,05	8,71

Prestazioni 10A Performances 10A

ARC	PRESSURE	RADIUS m	FLOW l/min
90°	1.38	3,05	1,7
	2.07	3,35	2,04
	2.76	3,66	2,35
	3.45	3,66	2,65
180°	1.38	3,05	3,41
	2.07	3,35	4,16
	2.76	3,66	4,73
	3.45	3,66	5,3
270°	1.38	3,05	5,11
	2.07	3,35	6,25
	2.76	3,66	7
	3.45	3,66	7,95
360°	1.38	3,05	6,81
	2.07	3,35	8,33
	2.76	3,66	9,46
	3.45	3,66	10,6

Prestazioni 12A Performances 12A

ARC	PRESSURE	RADIUS m	FLOW l/min
90°	1.38	3,66	2,46
	2.07	3,96	2,65
	2.76	4,27	3,03
	3.45	4,27	3,41
180°	1.38	3,66	4,92
	2.07	3,96	5,30
	2.76	4,27	6,06
	3.45	4,27	6,81
270°	1.38	3,66	7,19
	2.07	3,96	7,95
	2.76	4,27	9,08
	3.45	4,27	9,84
360°	1.38	3,66	8,33
	2.07	3,96	9,84
	2.76	4,27	11,73
	3.45	4,27	13,25

Prestazioni 15A Performances 15A

ARC	PRESSURE	RADIUS m	FLOW l/min
90°	1.38	4,27	2,84
	2.07	4,57	3,22
	2.76	4,57	3,60
	3.45	5,18	4,16
180°	1.38	4,27	5,30
	2.07	4,57	6,44
	2.76	4,57	7,19
	3.45	5,18	8,71
270°	1.38	4,27	8,52
	2.07	4,57	9,65
	2.76	4,57	10,60
	3.45	5,18	12,87
360°	1.38	4,27	11,36
	2.07	4,57	12,87
	2.76	4,57	14,38
	3.45	5,18	17,41

Prestazioni 17A Performances 17A

ARC	PRESSURE	RADIUS m	FLOW l/min
90°	1.38	5,18	3,22
	2.07	5,18	3,60
	2.76	5,49	3,97
	3.45	5,49	4,54
180°	1.38	4,88	6,44
	2.07	5,18	7,19
	2.76	5,49	7,95
	3.45	5,49	9,08
270°	1.38	4,88	9,46
	2.07	5,18	10,60
	2.76	5,49	11,92
	3.45	5,49	13,63
360°	1.38	4,88	12,87
	2.07	5,18	14,38
	2.76	5,49	15,90
	3.45	5,49	18,17

Code	Models
280.1300200	CORPO (BODY) S020 5CM - PRO
280.1300208	S020 5CM 8A - PRO
280.1300210	S020 5CM 10A - PRO
280.1300212	S020 5CM 12A - PRO
280.1300215	S020 5CM 15A - PRO
280.1300217	S020 5CM 17A - PRO

Code	Models
280.1300400	CORPO (BODY) S020 10CM - PRO
280.1300408	S020 10CM 8A - PRO
280.1300410	S020 10CM 10A - PRO
280.1300412	S020 10CM 12A - PRO
280.1300415	S020 10CM 15A - PRO
280.1300417	S020 10CM 17A - PRO
270.1053429	VALVOLA ANTIDRENAGGIO (CHECK VALVE) S020 - PRO

S030

Irrigatore statico
1/2" Sprays



Caratteristiche tecniche

- Pressione di esercizio 1.4 - 4.8 bar
- Attacco 1/2" F

Technical characteristics

- Operating pressure: 1.4 - 4.8 bar
- Inlet: 1/2" Female Thread

Caratteristiche e vantaggi

Alzo 10 cm
Guarnizione co-stampata: Assicura un funzionamento a comparsa completo e senza perdite anche in situazioni di bassa pressione. Il design della cartuccia consente una facile rimozione e pulizia. Trattato con inibitori UV per una lunga durata. Il materiale della guarnizione è stato accuratamente selezionato per ridurre il degrado
Accetta testine femmine
Molla di rientro che permette la chiusura dell'irrigatore in qualsiasi condizione
L'irrigatore permette di regolare l'orientamento del getto ruotando l'alzo
Valvola antidenagaggio opzionale

Features and benefits

Riser Height: 10 cm
Co-Molded Wiper Seal: Ensures a leak free, full pop-up operation even under low-pressure situations. Cartridge design allows for easy removal and cleaning. Treated with UV inhibitors for long life. Seal material was carefully selected to reduce degradation and stick-ups.
Accepts Female Threaded Nozzles
Heavy-Duty Retraction Spring - Strongest spring in the industry for positive retraction in all soil conditions
Ratcheting Riser - Allows for easy pattern alignment by turning the riser
Optional check valve - prevents low head drainage

Code	Models
270.1078004	S030 S 1/2"
270.1053428	VALVOLA ANTIDRENAGGIO (CHECK VALVE) S030

S050

Irrigatore dinamico
1/2" Rotors

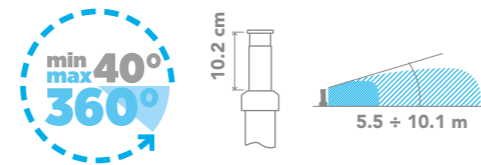

Prestazioni Performances			
UGELLO Nozzle	PRESSURE bar	RADIUS m	FLOW RATE l/min
#0.75	2,07	5,5	2,8
	2,76	5,8	3,0
	3,45	6,1	3,4
#1.0	2,07	7,9	3,4
	2,76	8,2	4,5
	3,45	8,2	4,9
#1.5 Pre-installed	2,07	8,2	5,7
	2,76	8,2	6,8
	3,45	8,5	7,6
#2.0	2,07	8,8	7,6
	2,76	9,1	8,7
	3,45	9,4	10,2
#3.0	2,07	9,8	11,4
	2,76	10,1	12,9
	3,45	10,1	14,4

Caratteristiche e vantaggi

Partenza dalla posizione destra: il rotore ruota in senso antiorario dalla posizione iniziale fissata a destra

Copertura in gomma - non fa entrare lo sporco e aumenta la durata del prodotto

Meccanismo di inversione brevettato collaudato nel tempo: assicura inversione e ritorno continui

L'irrigatore permette di regolare l'orientamento del getto ruotando l'alzo

Ampia selezione di ugelli: offre flessibilità nella progettazione del sistema

Valvola antidrenaggio opzionale

Features and benefits

Right position start – rotor rotates counterclockwise from fixed right start position

Rubber cover – seals out dirt and increases product durability

Time proven patented reversing mechanism – Assures continuous reverse and return

Ratcheting Riser–Allows for easy pattern alignment by turning the riser

Wide selection of nozzles – provides flexibility in system design

Optional check valve – prevents low head drainage

Caratteristiche tecniche

- Attacco 1/2"
- Settori regolabili da 40° a 360°
- Portata ugelli: 2.8 - 14.4 l/min
- Pressione di esercizio: 2.07 - 3.45 bar
- Precipitazione: 0.5 - 1 cm per ora (a seconda della distanza e dell'ugello usato)
- Altezza totale: 15.2 cm
- Distanza consigliata: da 5.2 a 8.5 m
- Raggio: da 5.5 a 10.7 m
- Angolo di traiettoria 26°
- alzo 10.2 cm

Technical characteristics

- Inlet: 1/2"
- Arc Adjustment Range: 40°- 360°
- Flow Range: 2,8 - 14,4 l/m
- Operating pressure: 2,07 - 3,45 Bar
- Precipitation Rate: 0,5 to 1 cm per Hour (Depending on Spacing and nozzle Used)
- Overall Height: 15,2 cm
- Recommended Spacing: 5,2 to 8,5 m
- Radius: 5,5 to 10,7 m
- Nozzle Trajectory: 26°
- Riser Height: 10,2 cm

Code	Models
280.1290101	S050 1/2" - PRO
270.1010507	SERIE UGELLI (NOZZLES) 1/2" (S050-S050S) - PRO
270.1010503	VALVOLA ANTIDRENAGGIO (CHECK VALVE) S050 - S050S - PRO
270.1010509	STRUMENTO DI REGOLAZIONE (ADJUSTMENT TOOL)

S050 S

Irrigatore dinamico
1/2" Rotors

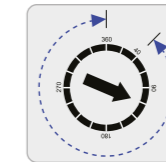
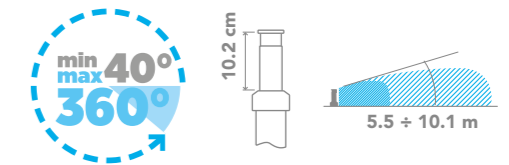

Prestazioni Performances			
UGELLO Nozzle	PRESSURE bar	RADIUS m	FLOW RATE l/min
#0.75	2,07	5,5	2,8
	2,76	5,8	3,0
	3,45	6,1	3,4
#1.0	2,07	7,9	3,4
	2,76	8,2	4,5
	3,45	8,2	4,9
#1.5 Pre-installed	2,07	8,2	5,7
	2,76	8,2	6,8
	3,45	8,5	7,6
#2.0	2,07	8,8	7,6
	2,76	9,1	8,7
	3,45	9,4	10,2
#3.0	2,07	9,8	11,4
	2,76	10,1	12,9
	3,45	10,1	14,4

Caratteristiche e vantaggi

Partenza dalla posizione sinistra: il rotore ruota in senso antiorario dalla posizione iniziale fissata a destra

ARC SET DEGREE. La visualizzazione dell'angolo di lavoro impostato consente un risparmio fino al 75% di tempo per la regolazione dell'angolo di lavoro.

Meccanismo di inversione brevettato collaudato nel tempo: assicura inversione e ritorno continui

L'irrigatore permette di regolare l'orientamento del getto ruotando l'alzo

Ampia selezione di ugelli: offre flessibilità nella progettazione del sistema

Valvola antidrenaggio opzionale

Features and benefits

Left position start – rotor rotates clockwise from fixed left start position

Patented Arc Set Degree Markings– Clearly indicates the current watering pattern and simplifies arc set adjustment

Time proven patented reversing mechanism – Assures continuous reverse and return

Ratcheting Riser–Allows for easy pattern alignment by turning the riser

Wide selection of nozzles – provides flexibility in system design

Optional check valve – prevents low head drainage

Code	Models
280.1290102	S050 S 1/2" - PRO
270.1010507	SERIE UGELLI (NOZZLES) 1/2" (S050-S050S) - PRO
270.1010503	VALVOLA ANTIDRENAGGIO (CHECK VALVE) S050 - S050S - PRO
270.1010519	STRUMENTO DI REGOLAZIONE (ADJUSTMENT TOOL)

S075 S

Irrigatore dinamico
3/4" Rotors

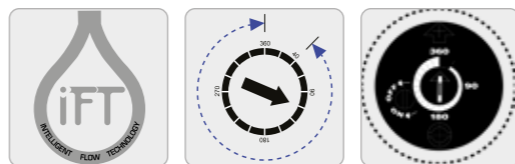
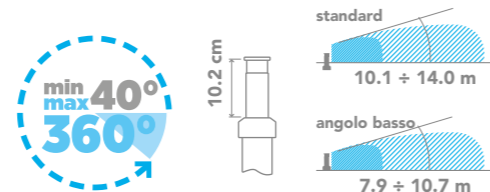

Prestazioni ad angolo standard Standard angle Performances				25°	Prestazioni angolo basso Low angle performances				11°		
UGELLO Nozzle	PRESSURE bar	RADIUS m	FLOW RATE l/min		UGELLO Nozzle	PRESSURE bar	RADIUS m	FLOW RATE l/min			
#1.0	2,1	10,1	4,5	#1.0	2,1	7,9	4,2	#1.0	2,1	7,9	4,2
	2,8	10,1	4,9		2,8	9,1	4,9		2,8	9,1	4,9
	3,4	10,1	5,7		3,4	9,1	5,3		3,4	9,1	5,3
	4,1	10,1	6,8		4,1	9,1	6,1		4,1	9,1	6,1
#1.5	2,1	11,0	5,7	#1.5	2,1	8,2	5,3	#1.5	2,1	8,2	5,3
	2,8	11,3	6,8		2,8	8,5	6,4		2,8	8,5	6,4
	3,4	11,3	7,6		3,4	9,4	7,2		3,4	9,4	7,2
	4,1	11,6	8,3		4,1	9,1	7,9		4,1	9,1	7,9
#2.0	2,1	10,7	6,8	#2.0	2,1	9,1	7,9	#2.0	2,1	9,1	7,9
	2,8	10,7	8,3		2,8	9,4	9,1		2,8	9,4	9,1
	3,4	11,0	9,8		3,4	10,1	10,6		3,4	10,1	10,6
	4,1	11,6	11,0		4,1	9,4	11,7		4,1	9,4	11,7
#2.5 Pre- installed	2,1	11,3	9,5	#3.0	2,1	9,8	11,4	#3.0	2,1	9,8	11,4
	2,8	11,6	11,4		2,8	10,4	13,2		2,8	10,4	13,2
	3,4	12,2	12,9		3,4	10,7	14,8		3,4	10,7	14,8
	4,1	12,2	14,4		4,1	10,7	16,3		4,1	10,7	16,3
#3.0	2,1	11,0	11,4	#4.0	2,1	11,3	15,1	#4.0	2,1	11,3	15,1
	2,8	11,3	12,9		2,8	11,6	17,0		2,8	11,6	17,0
	3,4	11,6	15,1		3,4	12,2	19,7		3,4	12,2	19,7
	4,1	12,5	16,7		4,1	12,2	21,2		4,1	12,2	21,2
#4.0	2,1	11,3	18,2	#5.0	2,1	11,3	18,2	#5.0	2,1	11,3	18,2
	2,8	11,6	21,2		2,8	11,6	21,2		2,8	11,6	21,2
	3,4	12,5	24,6		3,4	12,5	24,6		3,4	12,5	24,6
	4,1	13,1	27,3		4,1	13,1	27,3		4,1	13,1	27,3
#6.0	2,1	12,2	22,7	#8.0	2,1	12,2	22,7	#8.0	2,1	12,2	22,7
	2,8	12,5	25,7		2,8	13,4	34,8		2,8	13,4	34,8
	3,4	12,8	28,4		3,4	13,7	39,4		3,4	13,7	39,4
	4,1	13,4	31,8		4,1	14,0	42,0		4,1	14,0	42,0

Caratteristiche e vantaggi

Partenza dalla posizione sinistra: il rotore ruota in senso antiorario dalla posizione iniziale fissata a destra

ARC SET DEGREE. La visualizzazione dell'angolo di lavoro impostato consente un risparmio fino al 75% di tempo per la regolazione dell'angolo di lavoro.

Meccanismo di inversione brevettato collaudato nel tempo: assicura inversione e ritorno continui

L'irrigatore permette di regolare l'orientamento del getto ruotando l'alzo

Ampia selezione di ugelli: offre flessibilità nella progettazione del sistema

Valvola antidrenaggio opzionale

Features and benefits

Left position start – rotor rotates clockwise from fixed left start position

Patented Arc Set Degree Markings – Clearly indicates the current watering pattern and simplifies arc set adjustment

Time proven patented reversing mechanism – Assures continuous reverse and return

Ratcheting Riser – Allows for easy pattern alignment by turning the riser

Wide selection of nozzles – provides flexibility in system design

Optional check valve – prevents low head drainage

Caratteristiche tecniche

- Attacco 3/4"
- Settori regolabili da 40° a 360°
- Portata ugelli: 4,2 - 42,0 l/min
- Pressione di esercizio 2,1 - 4,1 bar
- Precipitazione: 0,3 - 2,9 cm per ora (a seconda della distanza e dell'ugello usato)
- Altezza totale: 18,7 cm
- Distanza consigliata: da 7,6 a 13,7 m
- Raggio: da 6,7 a 15,5 m
- Traiettoria angolo standard: 25°
- Traiettoria ad angolo basso: 11°
- 8 ugelli standard e 4 ugelli ad angolo basso inclusi
- alzo 10,2 cm

Technical characteristics

- Inlet: 3/4"
- Arc Adjustment Range: 40° to 360°
- Flow Range: 4,2 - 42,0 l/min
- Operating pressure: 2,1 - 4,1 Bar
- Precipitation Rate: 0,3 to 2,9 cm per Hour (Depending on Spacing and nozzle Used)
- Overall Height: 18,7 cm
- Recommended Spacing: 7,6 to 13,7 m
- Radius: 6,7 to 15,5 m
- Nozzle Trajectory: 25°
- Low Angle Nozzle Trajectory: 11°
- 8 standard and 4 Low Angle Nozzle Included
- Riser Height: 10,2 cm

Code	Models
280.1170100	S075 S - 3/4" - PRO
270.1010520	VALVOLA ANTIDRENAGGIO (CHECK VALVE) 3/4" (S075S) - PRO
270.1010520	SERIE UGELLI VERDI (GREEN NOZZLES) 3/4" (S075D - S075S) - PRO
270.1010510	SERIE UGELLI ROSSI (RED NOZZLES) 3/4" (S075D - S075S) - PRO
270.1010519	STRUMENTO DI REGOLAZIONE (ADJUSTMENT TOOL)

S100

Irrigatore dinamico
1" Rotors

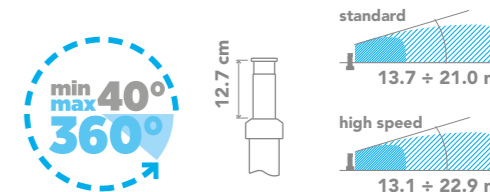

Prestazioni standard Standard Performances				Prestazioni High Speed High Speed Performances			
UGELLO Nozzle	PRESSURE bar	RADIUS m	FLOW RATE l/min	UGELLO Nozzle	PRESSURE bar	RADIUS m	FLOW RATE l/min
#5	2,8	13,7	19,3	#5	2,8	13,1	22,3
	3,5	14,3	22,3		3,5	13,4	23,5
	4,1	14,3	24,6		4,1	13,7	24,2
	4,8	14,9	26,9		4,8	13,7	28,8
#10 Pre- installed	3,5	16,2	40,1	#10	3,5	14,9	40,1
	4,1	15,9	44,7		4,1	15,8	44,3
	4,8	16,2	47,7		4,8	16,1	50,3
	5,5	16,8	51,1		5,5	16,5	53,0
#15	3,5	17,4	49,2	#15	3,5	15,8	46,9
	4,1	18,0	53,8		4,1	16,5	55,3
	4,8	18,0	58,3		4,8	17,1	58,7
	5,5	19,2	62,5		5,5	17,1	60,2
#20	4,1	19,8	71,5	#20	4,1	17,1	66,2
	4,8	20,4	77,6		4,8	17,7	71,5
	5,5	21,0	82,9		5,5	18,0	78,7
	6,2	21,6	87,8		6,2	18,3	82,1
#25	4,1	20,4	86,3	#25	4,1	18,0	84,8
	4,8	21,6	93,9		4,8	20,1	97,3
	5,5	22,9	100,3		5,5	20,4	105,2
	6,2	23,5	101,4		6,2	20,7	113,2
#30	4,1	20,4	89,7	#30	4,1	18,3	95,4
	4,8	21,0	96,9		4,8	22,0	107,9
	5,5	21,0	104,1		5,5	22,2	116,6
	6,2	21,6	110,5		6,2	22,9	123,0

Caratteristiche e vantaggi

ARC SET DEGREE. La visualizzazione dell'angolo di lavoro impostato consente un risparmio fino al 75% di tempo per la regolazione dell'angolo di lavoro.

Ugello con triplo getto per una migliore distribuzione dell'acqua

Regolazione 2in1 consente la regolazione da 40° a 360° con rotazione continua

Arc Memory Clutch: impedisce il danneggiamento dell'ingranaggio interno e riporta automaticamente l'angolo di lavoro nella posizione desiderata se la torretta porta ugello viene forzata oltre l'arresto.

Meccanismo di inversione brevettato collaudato nel tempo: assicura inversione e ritorno continui

L'irrigatore permette di regolare l'orientamento del getto ruotando l'alzo

Copertura in gomma resistente e parafango - Protegge da lesioni fisiche e riduce i rischi, consente di installare l'irrigatore sottola superficie del terreno.

Features and benefits

Patented Arc Set Degree Markings – Clearly indicates the current watering pattern and simplifies arc set adjustment

Triple Nozzle Configuration – Ensures even distribution of water.

2N1 Adjustable or Continuous Rotation – Provides a full range of adjustment from 40° to a continuous full circle

Arc Memory Clutch – Prevents internal gear damage and returns rotor to its prior setting automatically if nozzle turret is forced past stop.

Time Proven Patented Reversing Mechanism – Assures continuous reverse and return...over a 35 year history

Ratcheting Riser – Allows for easy adjustment of your fixed starting position with a simple turn of the riser

Heavy Duty Rubber Cover and Mud Guard – Protects against physical injury and reduces liability, allows sprinkler to be installed below grade.

Caratteristiche tecniche

- Attacco 1" F
- Settori regolabili da 40° a 360°
- Portata ugelli: 19,3 - 110,5 l/min
- Pressione di esercizio: min 2,8 bar max 4,8 bar
- Precipitazione: 1,5 to 12,0 cm per ora (Depending on Spacing and nozzle Used)
- Altezza corpo 24,13 cm
- Distanza consigliata: 12,20 a 19,80 m
- Raggio da 13,71 m a 23,46 m
- Angolo di traiettoria 26°
- 6 ugelli standard inclusi
- Alzo: 10,0 cm

Technical characteristics

- Inlet: 1" F
- Arc Adjustment Range: 40° - 360°
- Flow Range: 19,3 - 110,5 l/min
- Operating pressure: 2,8 - 4,8 Bar
- Precipitation Rate: 1,5 to 12,0 cm per Hour (Depending on Spacing and nozzle Used)
- Overall Height: 24,13 cm
- Recommended Spacing: 12,20 to 19,80 m
- Radius: 13,71 to 23,46 m
- Nozzle Trajectory: 26°
- 6 standard Nozzle Included
- Riser Height: 10,0 cm

Code	Models
280.1010400	S100 1" ADV - PRO - ABS BODY
280.1010450	S100 1" ADS - PRO - INOX BODY
280.1010460	S100 1" ADS HS - PRO - INOX BODY HIGH SPEED
270.1010511	SERIE UGELLI ROSSI (RED NOZZLES) 1" (S100 - PRO SPORT) - PRO
270.1010519	STRUMENTO DI REGOLAZIONE (ADJUSTMENT TOOL)

K-ROTARY

Irrigatore dinamico
Rotary type sprinkler

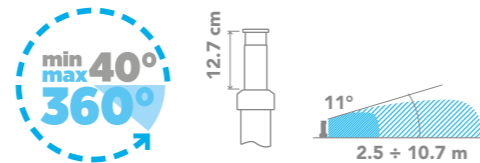

RNS-RES-515
Burnt Orange

bar	m	l/min
2,06	1,22 x 4,6	1,14
2,46	1,5 x 4,6	1,21
2,75	1,5x 4,6	1,32
3,10	1,8 x 4,9	1,43
3,45	1,8 x 4,9	1,51

RNS-LES-515
Olive

bar	m	l/min
2,06	1,22 x 4,6	1,14
2,46	1,5 x 4,6	1,21
2,75	1,5x 4,6	1,32
3,10	1,8 x 4,9	1,43
3,45	1,8 x 4,9	1,51

RNS-SS-530
Brown

bar	m	l/min
2,06	1,22 x 8,8	1,80
2,46	1,5 x 9,1	2,08
2,75	1,5x 9,1	2,30
3,10	1,8 x 9,4	2,46
3,45	2,1 x 9,7	2,64

Caratteristiche e vantaggi	Features and benefits
Installabile sugli irrigatori statici	Suitable for all sprinklers' bodies with male outlets
riduzione 30% consumo acqua	save up to 30% water
Riduzione dell'angolo fino al 20%	20% Radius Reduction
riduzione della gittata fino al 25%	operating range adjustable downto 25%

Caratteristiche tecniche	Technical characteristics
• Attacco 1/2"	• Inlet: 1/2"
• Pressione di esercizio min 2 bar max 3.5 bar	• Operating pressure: 2 - 3,5 Bar
• Portate testine da 0.8 l/min a 7.1 l/min	• Flow Range: 0,8 - 7,1 l/m
• Distanza consigliata: » Rotary 100: 2.4 - 4.2 m » Rotary 200: 4.2 - 6.3 m » Rotary 300: 6.6 - 8.4 m	• Recommended Spacing: » Rotary 100: 2.4 - 4.2 m » Rotary 200: 4.2 - 6.3 m » Rotary 300: 6.6 - 8.4 m

Code	Models
270.1700110	K-ROTARY STRISCIA SX (left strip) - PRO
270.1700130	K-ROTARY STRISCIA DX (right strip) - PRO
270.1700120	K-ROTARY CENTRO STRISCIA (side strip) - PRO
270.1090270	K-ROTARY 100 ADJ 90-270 - PRO
270.1000360	K-ROTARY 100 FIX 360 - PRO

Code	Models
270.2090270	K-ROTARY 200 ADJ 90-270 - PRO
270.2000360	K-ROTARY 200 FIX 360 - PRO
270.3090270	K-ROTARY 300 ADJ 90-270 - PRO
270.3000360	K-ROTARY 300 FIX 360 - PRO

RN100-ADJ-90-270
(MEDIUM GREEN)

ARC	bar	m	l/min
90°	2,07	3,96	0,83
	2,41	4,27	0,91
	2,76	4,27	0,94
	3,10	4,57	1,10
180°	2,07	3,96	1,66
	2,41	4,27	1,78
	2,76	4,27	1,89
	3,10	4,57	2,19
270°	2,07	3,96	2,50
	2,41	4,27	2,69
	2,76	4,27	2,84
	3,10	4,57	3,25
3,45	4,57	3,40	

RN100-FIX360
(LIGHT GREEN)

ARC	bar	m	l/min
360°	2,07	3,96	3,33
	2,41	4,27	3,56
	2,76	4,27	3,78
	3,10	4,57	4,35
3,45	4,57	4,54	

RN200-ADJ-90-270
(MEDIUM BLUE)

ARC	bar	m	l/min
90°	2,07	4,87	1,29
	2,41	5,18	1,44
	2,76	5,48	1,55
	3,10	5,79	1,59
180°	2,07	4,87	2,53
	2,41	5,18	2,84
	2,76	5,48	3,14
	3,10	5,79	3,18
270°	2,07	4,87	3,82
	2,41	5,18	4,28
	2,76	5,48	4,69
	3,10	5,79	4,77
3,45	5,79	5,34	

RN200-FIX360
(LIGHT BLUE)

ARC	bar	m	l/min
360°	2,07	4,87	5,07
	2,41	5,18	5,68
	2,76	5,48	6,24
	3,10	5,79	6,36
3,45	5,79	7,11	

RN300-ADJ-90-270
(MEDIUM GREY)

ARC	bar	m	l/min
90°	2,07	7,92	3,03
	2,41	7,92	3,22
	2,76	8,23	3,40
	3,10	8,23	3,59
180°	2,07	7,92	5,30
	2,41	8,23	5,68
	2,76	8,23	6,05
	3,10	8,84	6,43
270°	2,07	7,92	9,27
	2,41	8,23	9,65
	2,76	8,53	10,41
	3,10	8,53	10,98
3,45	8,23	11,73	

RN300-FIX360
(LIGHT GREY)

ARC	bar	m	l/min
360°	2,07	7,92	11,73
	2,41	8,23	12,11
	2,76	8,53	13,25
	3,10	8,53	13,43
3,45	9,1	14,00	

SUPER 635

Irrigatore dinamico
1" 1/2 Rotors

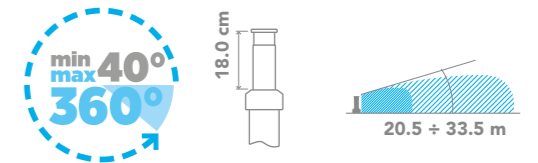

Caratteristiche tecniche

- attacco 1"1/2
- Settori regolabili da 40° a 360°
- Portate ugelli: 102 - 357 l/min
- Pressione di esercizio min 2,0 bar max 5,0 bar
- Altezza corpo 24,13 cm
- Distanza consigliata: da 20,0 m a 35 m
- Raggio: da 20 a 35 m
- 5 ugelli intercambiabili standard
- Alzo: 18,0 cm

Technical characteristics

- Inlet: 1"1/2
- Arc Adjustment Range: 40° to 360°
- Flow Range: 102 - 357 l/m
- Operating pressure: 2,0 - 5,0 Bar
- Overall Height: 52,0 cm
- Recommended Spacing: 20,0 to 35,0 m
- Radius: 20,0 to 35,0 m
- 5 standard Nozzle Included
- Riser Height: 18,0 cm

Prestazioni Performances			
Ugello Nozzle	bar	m	l/min
104	2,0	20,5	102
	3,0	23	124
	4,0	26	144
	5,0	28,5	165
124	2,0	21	127
	3,0	24	156
	4,0	27	180
	5,0	30	201
144	2,0	21,5	173
	3,0	26,5	212
	4,0	30,5	245
	5,0	33,5	274
164	2,0	22,0	225
	3,0	28,5	276
	4,0	31,5	319
	5,0	33,5	357

SUPER 645

Irrigatore dinamico
2" Rotors

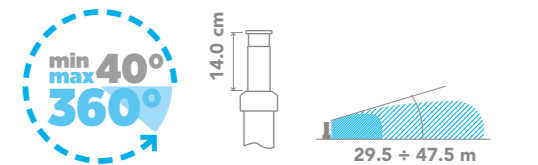

Caratteristiche tecniche

- attacco 2"
- Settori regolabili da 40° a 360°
- Portate ugelli: 314 - 1262 l/min
- Pressione di esercizio: min 3,0 bar max 8,0 bar
- Distanza consigliata: da 30,0 m a 50,00 m
- Raggio: da 29,5 a 50 m
- 6 ugelli intercambiabili standard

Technical characteristics

- Inlet: 2"
- Arc Adjustment Range: 40° to 360°
- Flow Range: 314 - 1262 l/m
- Operating pressure: 3,0 - 8,0 Bar
- Recommended Spacing: 30,0 to 50,0 m
- Radius: 29,5 to 50,0 m
- 6 standard Nozzle Included

Prestazioni Performances			
Ugello Nozzle	bar	m	l/min
166	3,0	29,5	314
	4,0	32,5	364
	5,0	35,0	406
	6,0	37,0	446
186	3,0	31,0	350
	4,0	34,0	405
	5,0	37,0	452
	6,0	39,0	496
206	4,0	35,0	545
	5,0	39,0	609
	6,0	43,0	668
	7,0	44,0	721
226	4,0	36,0	649
	5,0	39,5	726
	6,0	44,5	795
	7,0	47,5	859

Code	Models
250.6010442	SUPER 635 1"1/2 ADJ - PRO
250.6110442	SUPER 635 1"1/2 ADJ CON ERBA SINTETICA (SYNTHETIC HERB) - PRO

Code	Models
250.6010506	SUPER 645 2" ADJ - PRO



MICROIRRIGAZIONE
DRIP

MICROIRRIGAZIONE DRIP



ALA GOCCIOLANTE

Standard drip line

Caratteristiche tecniche	Technical characteristics
Gocciolatore da 2.1 l/h	Range: 2.1 l/h
Passo: 0,3 m	Drip pitch: 0.3 m
Pressione di esercizio: 0,8 - 2,5 bar	Operating pressure: 0.8 - 2.5 bar
Pipe diameter: 16mm	Pipe diameter: 16 mm
Manometro: 0,9 mm	Pipe gauge: 0.9 mm
Codice a barre	Barcode
Anti fessurazioni	Anti cracking
Applicazioni: Parchi, giardini commerciali e residenziali, culture erbacee	Applications: Parks, commercial and residential gardens, herbaceous cultures



Gocciolatore	Passo Gocciolatori (cm)								Distanza [m]
	0.20	0.30	0.40	0.50	0.60	0.70	1.00	1.50	
16/1.4	63	84	103	120	136	158	190	248	
16/2.2	45	60	73	86	97	113	136	177	
16/3.1	36	49	60	71	71	93	113	147	

(Pressione di esercizio = 2.0 atm; Dislivello = 0%)

ALA GOCCIOLANTE AUTOCOMPENSANTE

Pc drip line

Caratteristiche tecniche	Technical characteristics
Gocciolatore da 2.1 l/h	Range: 2.1 l/h
Passo antigoccia: 0,3 m	Drip pitch: 0.3 m
Pressione di esercizio: 0,8 - 2,5 bar	Operating pressure: 0.8 - 2.5 bar
Pipe diameter: 16mm	Pipe diameter: 16 mm
Manometro: 0,9 mm	Pipe gauge: 0.9 mm
Autocompensante	Compensating
Codice a barre	Barcode
Anti fessurazioni	Anti cracking
Applicazioni: Parchi, giardini commerciali e residenziali, culture erbacee	Applications: Parks, commercial and residential gardens, herbaceous cultures



Gocciolatore	Passo Gocciolatori (cm)								Distanza [m]
	0.20	0.30	0.40	0.50	0.60	0.70	1.00	1.50	
16/1.4	112	161	206	249	289	344	430	582	
16/2.2	97	138	176	212	245	291	362	488	
16/3.1	68	98	126	152	176	211	264	357	
20/1.4	168	241	308	371	431	515	642	869	
20/2.2	151	214	272	326	376	446	552	738	
20/3.1	102	147	188	227	263	315	394	534	

(Pressione di esercizio = 4.3 atm; Dislivello = 0%)

Code	Models	Code	Models
500.0136500	STANDARD NERO / BLACK 25 M	800.5030102	AUTOCOMPENSANTE MARRONE 25 M/ P.C. BROWN 25 M
500.0136600	STANDARD NERO / BLACK 50 M	800.5030101	AUTOCOMPENSANTE MARRONE 50 M/ P.C. BROWN 50 M
800.5020450	STANDARD NERO / BLACK 100 M	800.5020103	AUTOCOMPENSANTE MARRONE 100 M/ P.C. BROWN 100 M
800.5020125	STANDARD MARRONE / BROWN 25 M	800.5010400	AUTOCOMPENSANTE MARRONE 400 M/ P.C. BROWN 400 M
800.5010103	STANDARD MARRONE / BROWN 50 M		
800.5020102	STANDARD MARRONE / BROWN 100 M		

DRAGONFLY RAIN

Micro spray



Caratteristiche tecniche	Technical characteristics
Portata da 0 a 119 l/h	Range: 0 - 119 l/h
Raggio da 0 a 3,3 m	Radius: 0 - 3.3 m
Pressione da 0,5 a 2,5 bar	Operating pressure: 0.5 - 2.5 bar

SPIDER RAIN

Drip



Caratteristiche tecniche	Technical characteristics
Portata da 0 a 60 l/h	Range: 0 - 60 l/h
Raggio da 0 a 0,65 m	Radius: 0 - 0.65 m
Pressione da 1,0 a 2,0 bar	Operating pressure: 1.0 - 2.0 bar

BUTTERFLY RAIN

Drip



Caratteristiche tecniche	Technical characteristics
Portata da 0 a 74 l/h	Range: 0 - 74 l/h
Raggio da 0 a 3,4 m	Radius: 0 - 3.4 m
Pressione da 1,0 a 2,0 bar	Operating pressure: 1.0 - 2.0 bar

Code	Models
696.4031000	DRAGONFLY 90 REG. FIL. M 4 MM - PRO
696.4032000	DRAGONFLY 180 REG. FIL. M 4 MM - PRO
696.4034000	DRAGONFLY 360 REG. FIL. M 4 MM - PRO
696.6030400	SPIDER 360 REG. SU SPIKE IN-LINE - PRO
696.4030300	SPIDER 360 REG. SU SPIKE END-LINE - PRO
696.4037300	SPIDER 180 REG. SU SPIKE END-LINE - PRO

Code	Models
696.4030000	BUTTERFLY 360 REG. INNESTO 4MM - PRO
696.4030100	BUTTERFLY 360 REG. FIL. M 4MM - PRO



Prestazioni - Performances				
pressione bar	portata l/h	arco 360° raggio (cm)	arco 180° raggio (cm)	arco 90° raggio (cm)
16/1.4	112	206	289	430
	161	249	344	582
16/2.2	97	176	245	362
	138	212	291	488
16/3.1	68	126	176	264
	98	152	211	357



Prestazioni - Performances				
pressione bar	portata 360° (l/h)	arco 360° raggio (cm)	portata 180° (l/h)	arco 180° raggio (cm)
1.0	0 - 40	0 - 25	0 - 40	0 - 38
1.5	0 - 50	0 - 30	0 - 50	0 - 52
2.0	0 - 60	0 - 40	0 - 60	0 - 65



Prestazioni - Performances			
	pressione bar	portata l/h	arco 360° raggio (cm)
APERTURA TOTALE	1.0	0 - 52	0 - 85
	1.5	0 - 65	0 - 140
	2.0	0 - 74	0 - 170

BETTLE RAIN

Drip



Caratteristiche tecniche	Technical characteristics
Disponibili due versioni di Astine	Two versions of spikes available
Astine di Fine linea con Innesto di Ingresso 4,5 mm	end line spikes with 4.5 mm inlet connection
Astine In linea con Innesto di Ingresso e di Uscita di 4,5 mm	in line spikes with 4.5 mm inlet and outlet connection
Portata da 4,31 a 3,72 l/h	Range: 4.31 - 3.72 l/h
Pressione da 1,0 a 3,0 bar	Operating pressure: 1.0 - 3.0 bar

BUG RAIN

Drip



PICCHETTI

Pickets

Caratteristiche tecniche	Technical characteristics
confezionato in sacchetto di plastica	Packed in plastic bags
Altezza: 14 cm	Height: 14 cm
Per ala gocciolante diametro 16 e diametro 20	For drip lines diam. 16 mm, 20 mm and models of porous pipe.

Code	Models
696.3062500	BEETLE AC 4 L/H SU SPIKE END-LINE - PRO
696.3065500	BEETLE AC 4 L/H SU SPIKE IN-LINE - PRO
696.3032500	BUG AC 2 L/H INNESTO 4MM - PRO
696.3034800	BUG AC 4 L/H INNESTO 4MM - PRO

Code	Models
800.2100510	PICCHETTI PER TUBI D. 16-20 - CONF. 100 PZ - PRO
800.2100500	PICCHETTI PER TUBI D. 16-20 - CONF. 1000 PZ - PRO



Prestazioni - Performances	
STANDARD 4l/h	
pressione bar	portata l/h
1.0	4.31
1.5	3.97
2.0	3.85
2.5	3.82
3.0	3.72

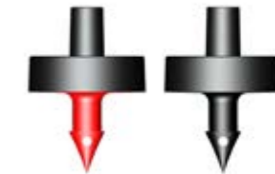

Caratteristiche tecniche	Technical characteristics
Ingresso 4,5 mm	Inlet 4.5 mm
Portata da 2 l/h	Range: from 2 l/h
Pressione da 1,0 a 3,0 bar	Operating pressure: 1.0 - 3.0 bar



VENTURIMETRO

Venturi injector



Caratteristiche tecniche	Technical characteristics
Fornisce i nutrienti alle piante direttamente nella zona bagnata	Delivers plant nutrients directly into the wetted zone
Valvola di ritegno incorporata per proteggere il liquido iniettato dal retro flusso	In-built check valve for protecting the injected liquid against back flow
Può essere utilizzato con un'ampia varietà di sostanze chimiche	Can be used with a large variety of chemicals
Applicazione uniforme di fertilizzanti	Uniform application of fertilizers
Risparmia energia e manodopera	Saves Energy & Manpower

KIT ASPIRAZIONE VENTURIMETRI

Venturi aspiration kit



I venturimetri sono disponibili nelle misure 3/4", 1" e 1 1/2" e sono studiati per le applicazioni ove sia necessario miscelare aria o liquidi alla linea principale. La loro applicazione non è utilizzata solo per l'irrigazione, ma anche per la chimica industriale.

Venturi are available in size 3/4", 1" and 1 1/2" and are studied to mix any kind of liquids or gas into the main pipes. Their application is not used for irrigation only, but also for chemical industrial use.

KIT DI REGOLAZIONE VENTURIMETRI

Venturi regulation kit



Caratteristiche tecniche	Technical characteristics
Flussimetro galleggiante	Rotameter: Float-Type
Indicatore della portata del flussimetro: 50-200 LPH	Rotameter Flow Rate Marking: 50-200 LPH
Conteggio minimo: 10 LPH	Least Count: 10 LPH

Code	Models
140.1000034	RNHV PLUS 3/4" M
140.1000100	RNHS PLUS 1" M
140.1000112	RNHS PLUS 1 1/2" M
140.1000200	RNHS PLUS 2" M
140.2000100	KIT ASPIRAZIONE VENTURI / ASPIRATION KIT 1" & 3/4"
140.2000112	KIT ASPIRAZIONE VENTURI / ASPIRATION KIT 1 1/2"

Code	Models
140.2000200	KIT ASPIRAZIONE VENTURI / ASPIRATION KIT 2"
140.2000000	KIT ASPIRAZIONE VENTURI / ASPIRATION KIT 1" & 1 1/2"
140.3000100	KIT REGOLAZIONE PER VENTURI / REGULATION KIT 1" & 3/4"
140.3000112	KIT REGOLAZIONE PER VENTURI / REGULATION KIT 1 1/2"
140.3000200	KIT REGOLAZIONE PER VENTURI / REGULATION KIT 2"

TEST IN LINEA / IN LINE TEST

MOD. 3/4"

Inlet pressure Bar	Outlet pressure bar	Suction l/h	Motive flow l/min
0.7	0.4	50	10
0.7	0.5	0	8
1	0	70	13
1	0.4	98	12.5
1	0.6	55	12
1	0.8	30	11.8
1.4	0	70	15
1.4	0.2	70	15
1.4	0.4	70	15
1.4	0.6	66	14.8
1.4	0.8	55	14.1
1.4	1	38	13.6
1.7	0	70	16.3
1.7	0.2	70	16.3
1.7	0.35	68	16.3
1.7	0.7	68	16.3
1.7	1	60	16
2.1	0	68	18.3
2.1	0.35	66	18.3
2.1	0	80	9

MOD. 1"

Inlet pressure Bar	Outlet pressure bar	Suction l/h	Motive flow l/min
0.7	0.4	150	30
0.7	0.5	105	30
1	0	220	33
1	0.4	198	32
1	0.6	135	30
1	0.8	0	28
1.4	0	200	40
1.4	0.2	200	40
1.4	0.4	200	40
1.4	0.6	190	38
1.4	0.8	138	35
1.4	1	100	35
1.7	0	200	42
1.7	0.2	197	42
1.7	0.35	197	42
1.7	0.7	195	42
1.7	1	180	41
2.1	0	195	47
2.1	0.35	195	47
-	-	-	-

MOD. 1 1/2"

Inlet pressure Bar	Outlet pressure bar	Suction l/h	Motive flow l/min
1	0	600	60
1	0.4	360	58
1	0.6	240	58
1	0.8	40	50
1.4	0	580	74
1.4	0.2	514	72
1.4	0.4	485	70
1.4	0.6	410	70
1.4	0.8	290	68
1.4	1	160	66
1.7	0	620	75
1.7	0.2	610	75
1.7	0.35	570	75
1.7	0.7	480	72
1.7	1	335	70
2.1	0	600	85
2.1	0.35	600	85
2.1	0.7	560	85
2.1	1	440	84
2.5	0	620	95
2.5	0.35	580	95
2.5	0.7	575	95
2.5	1.2	500	90

MOD. 1 1/2"

Inlet pressure Bar	Outlet pressure bar	Suction l/h	Motive flow l/min
3	0	630	115
3	0.35	630	115
3	0.7	625	115
3	1.2	600	110
3	1.5	560	110
4	0	620	130
4	0.5	610	130
4	1	600	130
4	0	600	130
4	1.5	560	125
4	2.5	450	120
4	3	250	120
5	0	610	150
5	0.5	610	150
5	1	620	145
5	1.5	620	145
5	2	600	140
5	2.5	580	140
5	3	470	140
5	3.5	285	135

MICROIRRIGAZIONE DRIP LINE

VISION SYSTEM VISION SYSTEM
CENTRALINE RICARICABILI RECHARGEABLE CONTROLS
CENTRALINE DA RUBINETTO TAP TIMERS
CENTRALINE IP68 CONTROLLERS
CENTRALINE CONTROLLERS
ELETTRIVALVOLE ELECTRIC VALVES
POZZETTI VALVE BOXES
RACCORDI PVC PVC FITTINGS
IRRIGATORI SPRINKLERS
MICROIRRIGAZIONE DRIP LINE

rain



HomeIrrigation



IRRIGAZIONE DI SUPERFICIE
SURFACE SYSTEM



IRRIGAZIONE A GOCCIA
DRIP



IRRIGAZIONE INTERRATA
LANDSCAPE & TURF

HOME IRRIGATION

Da quasi 10 anni Rain è presente nel mercato della grande distribuzione con il marchio "Homeirrigation" mettendo a disposizione degli amanti del Fai Da Te più di 50 anni di esperienza nel modo dell'irrigazione professionale.

Il marchio Rain Homerrigation è in grado di fornire una completa gamma di prodotti per l'irrigazione domestica dai raccordi rapidi per l'irrigazione di superficie alle centraline elettroniche per l'irrigazione automatica del giardino.

For almost 10 years, Rain has been present in the GDO market with the Homeirrigation brand, providing the DIY enthusiasts with more than 50 years of experience in professional irrigation. The Rain Homerrigation brand is able to provide a complete range of products for domestic irrigation from quick fittings for surface irrigation to electronic control units for automatic garden irrigation.



KIT
Irrigazione



30
VASI

il Mio Balcone

KIT
"CAPILLARE"

KIT
"GOCCIOLATORI
PRECISION"

KIT
"GOCCIOLATORI
PRECISION"
con centralina
AMICO+



25 m²

il Mio Orto

KIT
"ALA GOCCIOLANTE"

KIT
"TUBO POROSO"
con centralina
ZERO PRESSURE



il Mio Balcone



INSTALLAZIONE FACILE E VELOCE



il Mio Orto

RISPARMIA TEMPO
RISPARMIA ACQUA
RISPETTA L'AMBIENTE



KIT CAPILLARE

Kit balcone
Balcony kit

Componenti	Components
1 riduttore di pressione 3/4" F	1 pressure reduction 3/4" F
1 attacco rubinetto	1 tap adapter
3 gomiti portagomma Ø 16 mm	3 hose elbows Ø 16 mm
30 tubi capillari Ø 3 mm - 60 cm	30 pipes Ø 3 mm - 60 cm
1 chiavetta per foratura - fori Ø 4 mm	1 drilling key - holes Ø 4 mm
1 tubo PE Ø 16 mm - 15 cm	1 PE pipe Ø 16 mm - 15 cm
30 astine per capillari 13 cm	30 Pipe stakes 13 cm
4 tappi Ø 16 mm	4 plugs Ø 16 mm



KIT GOCCIOLATORI PRECISION

Kit balcone
Balcony kit

Componenti	Components
1 regolatore di pressione 3/4" F	1 pressure reduction 3/4" F
1 attacco rubinetto	1 tap adapter
4 gomiti portagomma Ø 16 mm	4 hose elbows Ø 16 mm
1 tubicino PE Ø 4 mm - 15 cm	1 PE pipe Ø 4 mm - 15 cm
30 clip di serraggio	30 clamps
1 tubo PE Ø 16 mm - 15 cm	1 PE pipe Ø 16 mm - 15 cm
30 gocciolatori su picchetto 14 cm	30 drippers on spike
1 tappo Ø 16 mm	1 plug Ø 16 mm



KIT GOCCIOLATORI PRECISION CON CENTRALINA AMICO +

Kit balcone
Balcony kit

Componenti	Components
1 centralina AMICO +	1 AMICO + controller
1 regolatore di pressione 3/4" F	1 pressure reduction 3/4" F
1 attacco rubinetto	1 tap adapter
4 gomiti portagomma Ø 16 mm	4 hose elbows Ø 16 mm
1 tubicino PE Ø 4 mm - 15 cm	1 PE pipe Ø 4 mm - 15 cm
30 clip di serraggio	30 clamps
1 tubo PE Ø 16 mm - 15 cm	1 PE pipe Ø 16 mm - 15 cm
30 gocciolatori su picchetto 14 cm	30 drippers on spike
1 tappo Ø 16 mm	1 plug Ø 16 mm



Code	Models
500.0138515	KIT CAPILLARE
500.3065500	KIT GOCCIOLATORI PRECISION
500.3032500	KIT GOCCIOLATORI PRECISION con centralina amico +



KIT ALA GOCCIOLANTE

Kit orto
Vegetable garden kit

Componenti	Components
1 riduttore di pressione 3/4" F	1 pressure reduction 3/4" F
1 attacco rubinetto	1 tap adapter
4 gomiti portagomma Ø 16 mm	4 hose elbows Ø 16 mm
8 tee portagomma Ø 16 mm	8 hose tee Ø 16 mm
10 picchetti 14 cm	10 spikes 14 cm
1 tubo PE Ø 16 mm - 15 cm	1 PE pipe Ø 16 mm - 15 cm
1 ala gocciolante piana Ø 16 mm - 25 m	1 drip line Ø 16 mm - 25 m
10 tappi Ø 16 mm	10 plugs Ø 16 mm



KIT TUBO POROSO

Kit orto
Vegetable garden kit

Componenti	Components
1 centralina PRESSURE ZERO	1 PRESSURE ZERO controller
1 regolatore di pressione 3/4" F	1 pressure reduction 3/4" F
1 tubo poroso Ø 16 mm - 25 m	1 Porous pipe Ø 16 mm - 25 m
10 picchetti 14 cm	10 spikes 14 cm



Code	Models
500.0138525	KIT ALA GOCCIOLANTE
500.0138526	KIT TUBO POROSO

MULTILINGUAL PACK



KIT PRECISION WITH AMICO + CONTROLLER

Kit balcone
Balcony kit

Componenti

- 1 centralina AMICO +
- 1 regolatore di pressione 3/4" F
- 1 attacco rubinetto
- 4 gomiti portagomma Ø 16 mm
- 1 tubicino PE Ø 4 mm - 15 cm
- 30 clip di serraggio
- 1 tubo PE Ø 16 mm - 15 cm
- 30 gocciolatori su picchetto 14 cm
- 1 tappo Ø 16 mm

Components

- 1 AMICO + controller
- 1 pressure reduction 3/4" F
- 1 tap adapter
- 4 hose elbows Ø 16 mm
- 1 PE pipe Ø 14 mm - 15 cm
- 30 clamps
- 1 PE pipe Ø 16 mm - 15 cm
- 30 drippers on spike
- 1 plug Ø 16 mm



Code	Models
500.0138527	KIT PRECISION WITH AMICO + CONTROLLER - MULTI PACK

MULTILINGUAL PACK



KIT DRIP LINE WITH ZERO PRESSURE CONTROLLER

Kit orto
Vegetable garden kit

Componenti

- 1 centralina Zero Pressure
- 1 riduttore di pressione 3/4" F
- 1 attacco rubinetto
- 4 gomiti portagomma Ø 16 mm
- 8 tee portagomma Ø 16 mm
- 10 picchetti 14 cm
- 1 tubo PE Ø 16 mm - 15 cm
- 1 ala gocciolante piana Ø 16 mm - 25 m
- 10 tappi Ø 16 mm

Components

- 1 Zero pressure controller
- 1 pressure reduction 3/4" F
- 1 tap adapter
- 4 hose elbows Ø 16 mm
- 8 hose tee Ø 16 mm
- 10 spikes 14 cm
- 1 PE pipe Ø 16 mm - 15 cm
- 1 drip line Ø 16 mm - 25 m
- 10 plugs Ø 16 mm



Code	Models
500.0128526	KIT DRIP LINE WITH ZERO PRESSURE CONTROLLER - MULTI PACK

THE **RAIN HOMERRIGATION** BRAND IS ABLE TO PROVIDE A COMPLETE RANGE OF PRODUCTS FOR DOMESTIC IRRIGATION FROM QUICK FITTINGS FOR SURFACE IRRIGATION TO ELECTRONIC CONTROL UNITS FOR AUTOMATIC GARDEN IRRIGATION.



IRRIGAZIONE DI SUPERFICIE
SURFACE SYSTEM



IRRIGAZIONE A GOCCIA
DRIP



IRRIGAZIONE INTERRATA
LANDSCAPE & TURF

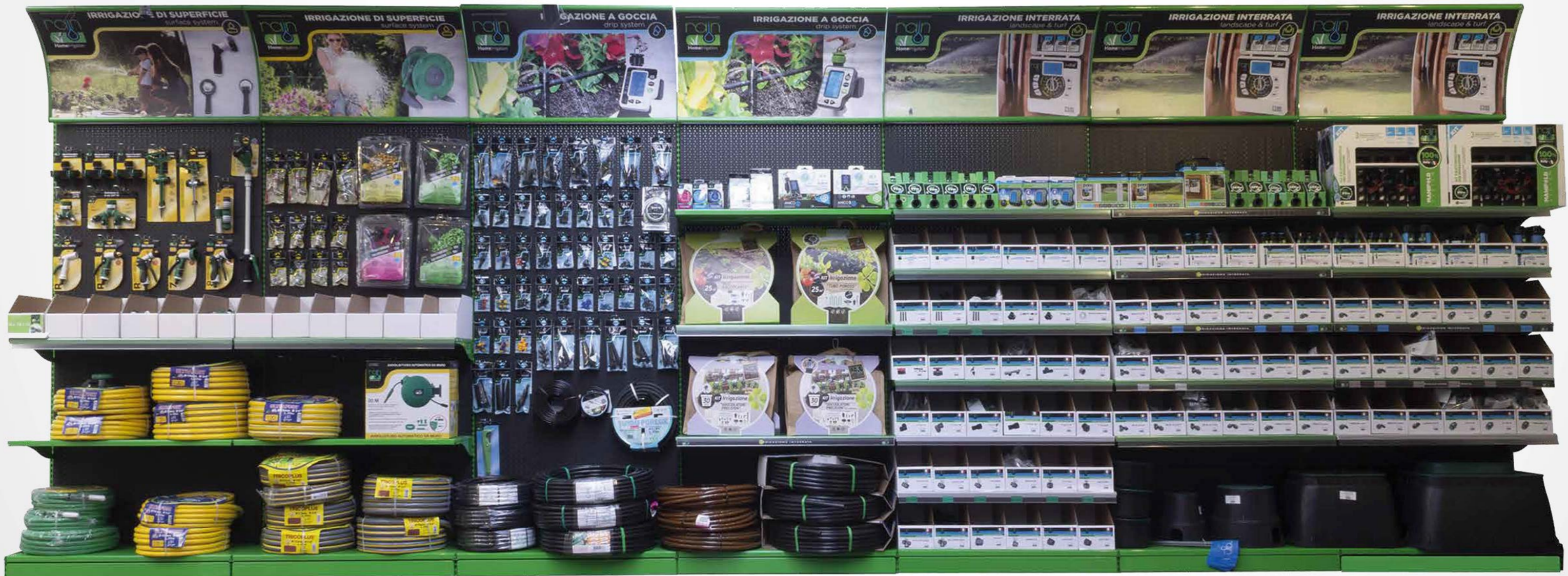

RAIN HOMERRIGATION



IRRIGAZIONE A GOCCIA
DRIP



IRRIGAZIONE INTERRATA
LANDSCAPE & TURF



IRRIGAZIONE DI SUPERFICIE
SURFACE SYSTEM

