



XF SERIES DRIPLINE | Design, Installation and Maintenance Guide



The Intelligent Use of Water™

INDEX | TABLE OF CONTENTS

Section 1 —	Introduction	3
	About Rain Bird / The Intelligent Use of Water	4
	Leed Library	5
	Benefits of Dripline Irrigation	6
Section 2 —	Preparation for Design	7
	Determine Soil Type	8
Section 3 —	Determine Dripline Specifications	9
Section 4 —	Determine Type of Dripline Layout	10-11
	End Feed / Center Feed	10
	Loop / Curved Edge	11
	Branching Out or Joining Row	12
	Slopes	13
	Determine Lateral Row Spacing	14
Section 5 —	Zone Water Calculations	15
	Calculating Application Rates	16
	Calculations for Dripline Irrigation	17
	Formulas for XF Series Dripline	18
Section 6 —	Dripline Application Overview	19
	XFD Flat Emitter	20
	XFD Dripline Specifications	21
	Lateral Run Lengths	21
	XFD Dripline - Where is it used?	22
	XFCV Dripline	23-24
	Lateral Run Lengths	24
	XFS Dripline with Copper Shield™ Technology	25-33
	XFS Dripline Specifications	26
	Applications / Benefits	27
	Trees / Curved Edges	28
	Design for Confined Areas	29
	Design for Large Areas	30
	Installation and Operation	31-32
	Recommended Practices	33
	1/4" Landscape Dripline	34
Section 7 —	Specifying Products in the Zone	35
	Control Zone Kit Features	35
	Commercial Control Zone Kit Selection Chart	36-37
	Fittings	38-39
	Spray-to-Drip Retrofit Kits	40
	Air Relief Valve	41
	Tie Down Stakes	41
	Manual Line Flush Point	41
	Xeri-Pop™ Operation Indicator	42
Section 8 —	Maintenance and Installation Tips	43
	XF Series Dripline Insert Adapters	43
	Preventative Maintenance: Flushing / Winterizing	44
	Written Specifications and CAD Detail Drawings	45
	Frequently Asked Questions	46
	Glossary	47



XFS Dripline



17mm XF Insert Fittings



XF Insertion Tool



Reclaimed Water Zone Kit

**SECTION 1:
INTRODUCTION**

This guide covers the basics of design, installation, and maintenance for Rain Bird's XF Series Dripline. Included are design steps, technical data, installation layouts and design details to assist in the design of the more common dripline applications.

A low volume irrigation system typically applies water slowly, at low pressure, at or near the root zones of plant material. Whether referred to as drip, micro irrigation, or low volume, these systems feature emission devices that apply water in gallons per hour (GPH) or liters per hour (l/hr) as opposed to the gallons per minute (GPM) or liters per minute (l/min) of a conventional overhead spray irrigation system.

Low-volume irrigation can greatly reduce or eliminate water waste while promoting healthier plant growth because you can:

- Match the amount of water applied to the specific need of each plant
- More closely match the application rate to the soil's infiltration rate
- Apply water directly to the root zone, reducing overspray and evaporation

Low-volume systems also reduce or eliminate runoff on walks and paved areas, and overspray onto windows, pavement, and walls. The Rain Bird Xerigation line of drip products offer a full range of water-saving choices for both turf and non-turf landscape applications, including control zone components, dripline, distribution components, emission devices and tools.

Use of dripline is a preferred method in many low-volume irrigation applications. Rain Bird's XF Series Dripline has in-line emitters that provide pressure compensation for precise flow control throughout the zone. XF Series Dripline is made with advanced polymers that provide kink-resistance and reduce coil memory for easier installation. With emitter flow rates of 0.4 GPH, 0.6, and 0.9 GPH (1.6 l/hr, 2.3 l/hr, and 3.4 l/hr) and emitter spacing at 12", 18" and 24" (0.30m, 0.45m and 0.61m), the XF Series provides a full product line to meet the needs of any application.

The Rain Bird XF Series of dripline products consists of:

- XFD Dripline – for on-surface applications
- XFS Dripline with Copper Shield™ Technology – for all sub-surface applications
- XFCV Dripline – with Heavy Duty Check Valve

For complete performance and technical specifications, please see Rain Bird's Landscape Irrigation Products Catalog or visit Rain Bird's website at www.rainbird.com. The website provides specifications and detail drawings in downloadable files.



ABOUT RAIN BIRD AND THE INTELLIGENT USE OF WATER



A privately held company founded in 1933, Rain Bird Corporation is the leading manufacturer and provider of irrigation products and services. Since its beginnings, Rain Bird has offered the industry’s broadest range of irrigation products for farms, golf courses, nurseries, sports arenas, commercial developments and homes in more than 130 countries around the world. With the broadest product line in the industry, architects, designers and contractors recognize Rain Bird as the industry leader in irrigation solutions.

Rain Bird is committed to The Intelligent Use of Water™. It is our legacy to design and manufacture only those products of the highest value, quality, and efficient application of water. We work for long-term, responsible partnerships with our customers and our suppliers. This is who we are, and this is how we wish to be perceived in the irrigation industry and our communities.

Please visit The Intelligent Use of Water section of our website to explore additional resources to help you design the most water-efficient projects.

<http://www.rainbird.com/landscape/resources/IUOW.htm>

Water Source

Need

Preserve potable water through alternative sourcing that taps into underutilized supplies such as underground well water, grey water and rain water.

Rain Bird Solution

- Non-potable-water-ready:
 - Valves
 - Rotors
 - Sprays
 - Drip products

Apply

Need

Distribute water to your landscape as efficiently as possible.

Rain Bird Solution

- Water-smart rotor and spray features:
 - Pressure Regulating Stem (PRS) technology
 - Seal-A-Matic™ (SAM) check valves
- High-efficiency Nozzles:
 - Rain Curtain™ Nozzles
 - U-Series Nozzles
 - Matched Precipitation Rate (MPR) Nozzles
 - Xeri Pressure Compensating Nozzles (XPCN)
- Landscape Drip: Direct-to-plant-root watering devices.

Design & Manage

Need

Receive support from a certified professional trained to design, install, operate and maintain a water-efficient system.

Rain Bird Solution

Rain Bird’s Contractor Referral Program helps you quickly and easily find a qualified irrigation contractor in your area.

Schedule

Need

Flexible programming schedules that help you customize a watering schedule based on the needs of your landscape.

Rain Bird Solution

- Our controllers offer:
- Cycle+Soak feature allowing for the most efficient water delivery.
 - Easy, push-of-the-button adjustments for seasonal changes.
 - Weather-based controllers which adjust based on hourly weather data.

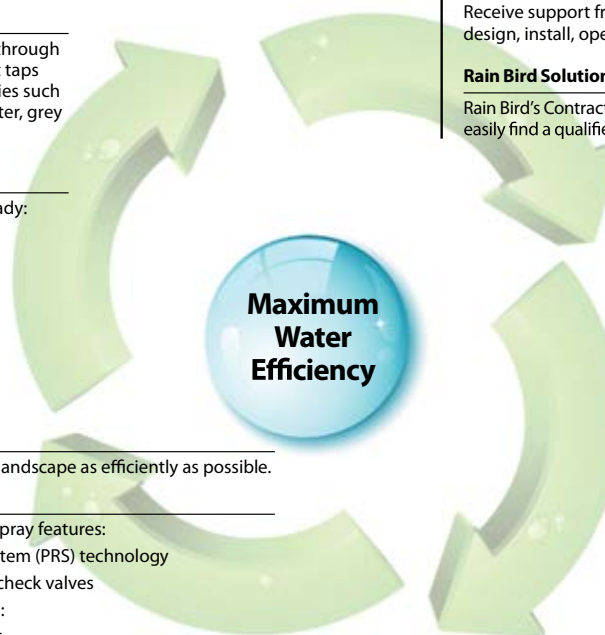

LEED LIBRARY
DESIGN & TECHNICAL RESOURCES



WHAT IS LEED?

The Leadership in Energy and Environmental Design (LEED) Green Building Rating System™ is a point rating system devised by the United States Green Building Council (USGBC) to evaluate the environmental performance of a building over its life cycle and to encourage market transformation towards sustainable design. LEED is the nationally recognized benchmark for the design, construction, and operation of high performance green buildings. LEED provides building owners and operators with the tools they need to have an immediate and measurable impact on their buildings' performance. LEED promotes a whole-building approach to sustainability by recognizing performance in five key areas of human and environmental health: sustainable sites, water savings, energy efficiency, materials selection, and indoor environmental quality.

Detailed information on obtaining credits and the project certification process is available from the USGBC on their website: www.usgbc.org.

WATER EFFICIENCY CREDIT 1.1

WATER EFFICIENCY LANDSCAPING: Reduce by 50% 2 points

Intent

Limit or eliminate the use of potable water, or other natural surface water resources available on or near the project site, for landscape irrigation.

Requirements

Reduce potable water consumption for irrigation by 50% from a calculated mid-summer baseline case. Reductions shall be attributed to any combination of the following items:

- Plant species factor
- Irrigation efficiency
- Use of captured rainwater
- Use of recycled wastewater
- Use of water treated and conveyed by a public agency for non-potable uses.

Rain Bird Notes

The designer on the LEED project will need to provide an irrigation plan and legend, as well as calculations, a description of the baseline, and cut sheets of the irrigation system demonstrating how water consumption is reduced by 50%.

Learn more at: <http://www.rainbird.com/landscape/resources/LEEDlibrary.htm>

Dripline irrigation can greatly reduce or eliminate water waste while promoting healthier plant growth for the following reasons:

- Match the water application to the specific needs of each plant
- More precisely match the application rate to the soil's infiltration rate
- Apply water directly to the root zone to reduce overspray and evaporation
- A properly designed and installed dripline irrigation system can be over 90% efficient

There are many advantages of dripline irrigation that can provide solutions for difficult-to-irrigate landscape areas:

- Narrow turf areas
- Curved narrow landscape areas
- Sloped areas
- Sub-surface turf irrigation applications
- Parking lot islands
- Steep sloped areas

Other benefits of on-surface or sub-surface Drip Irrigation:

- Eliminate runoff on walks and paved areas
- Prevent overspray onto windows, walls and fences
- Increase watering uniformity
- Reduce susceptibility to vandalism
- Promote healthy plant growth

To view all dripline models online, visit:

<http://www.rainbird.com/dripline>

BENEFITS OF DRIPLINE IRRIGATION

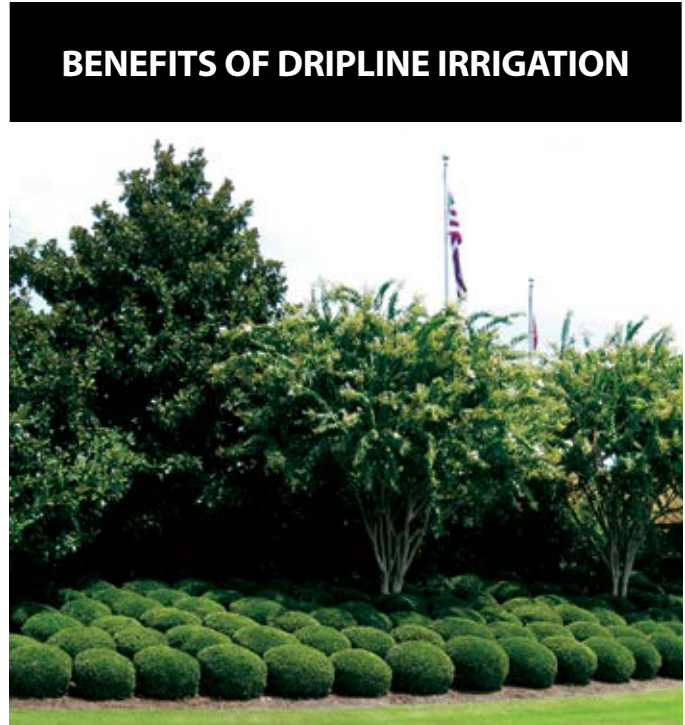

SECTION 2:
PREPARATION FOR DESIGN

Dripline system design follows many of the same rules as spray and rotor design. Similar design factors must be considered, such as point of connection, static and operating pressures, flow rates, and plant material.

A dripline system when properly designed and installed will deliver full irrigation coverage to the planted area. A dripline system is normally divided into zones. A typical zone contains a water source, a control zone (valve, filter, and pressure regulator), and the dripline with connection fittings.

During the preparation for design you will gather essential information to design the dripline system.

- Obtain or draw a scaled plan of the site to be irrigated
- Identify all of the slopes on the plan
- Determine the types of plants to be irrigated (groundcover, shrubs, turfgrass, and trees)
- Identify the type of soil (Clay, Loam, Sand)
- Identify the type of water from the water source (potable, non-potable, well, surface water, etc)
- Identify static and operating pressures, and volume available from the water source

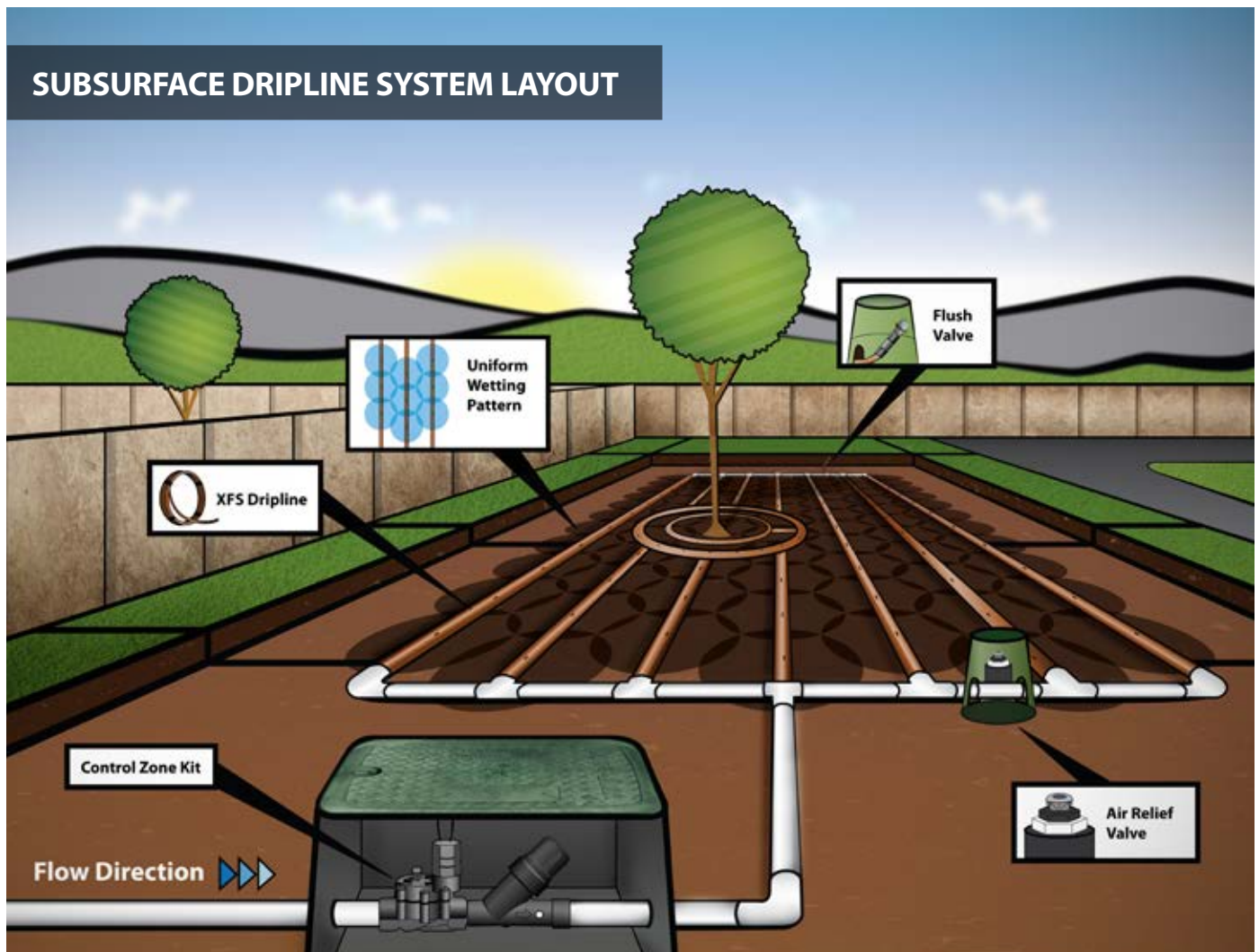

TABLE 1: OVERALL DESIGN PLAN FOR THE SITE

Soil Infiltration Rates (in Inches per Hour)			
Percent of Slope	Clay	Loam	Sand
0% - 4%	0.13 - 0.44	0.44 - 0.88	0.88 - 1.25
5% - 8%	0.1 - 0.35	0.35 - 0.7	0.7 - 1

Soil Infiltration Rates (in CM per Hour)			
Percent of Slope	Clay	Loam	Sand
0% - 4%	0.33 - 1.12	1.12 - 2.24	2.24 - 3.18
5% - 8%	0.25 - 0.89	0.89 - 1.78	1.78 - 2.54

Note: As the slope increases, infiltration rates will continue to decrease. These values are derived from USDA information.

DETERMINE SOIL TYPE WHAT IS YOUR SOIL TYPE?

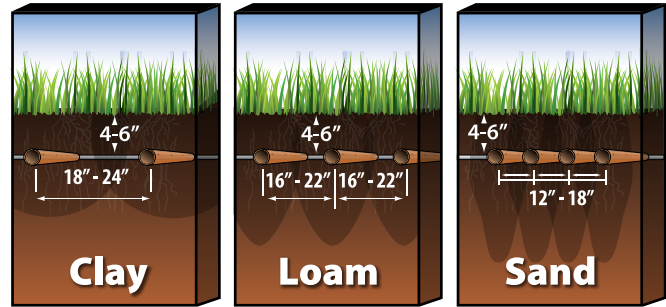

These illustrations show water movement in a sub-surface application. These guidelines apply to on-surface as well as sub-surface installations.

The objective of a well-designed dripline system is to create an even wetting pattern of water in the soil throughout the planting zone. There are four factors to consider for planting areas to create an even wetting pattern:

- Soil type (Clay, Loam, Sand)
- Emitter flow rate: 0.4 GPH, 0.6 GPH or 0.9 GPH (1.6 l/hr, 2.3 l/hr or 3.4 l/hr)
- Emitter spacing: 12", 18" or 24" (0.30m, 0.45m or 0.61m)
- Lateral spacing (distance between the dripline rows)

SOIL TYPE TEST

1. Remove 1 to 2 cups of soil from the zone to be irrigated.
2. Place into a glass jar, like a mason jar.
3. Fill the jar half way with water. Shake and let sit for 2 hours so the particles can settle. The heavier sand particles will settle to the bottom, then silt, then clay on top.
4. Measure the height of all 3 layers of the soil then the height of each layer; divide the height of each layer by the total height to figure out the percentage of each soil in the jar.
5. Apply these figures to the "Soil Classification" chart. In the example, now you know the landscape soil is silt loam.

Measure total height and layer heights

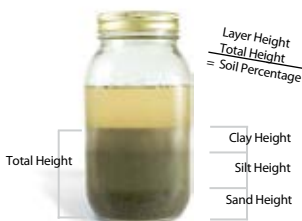

For Example:

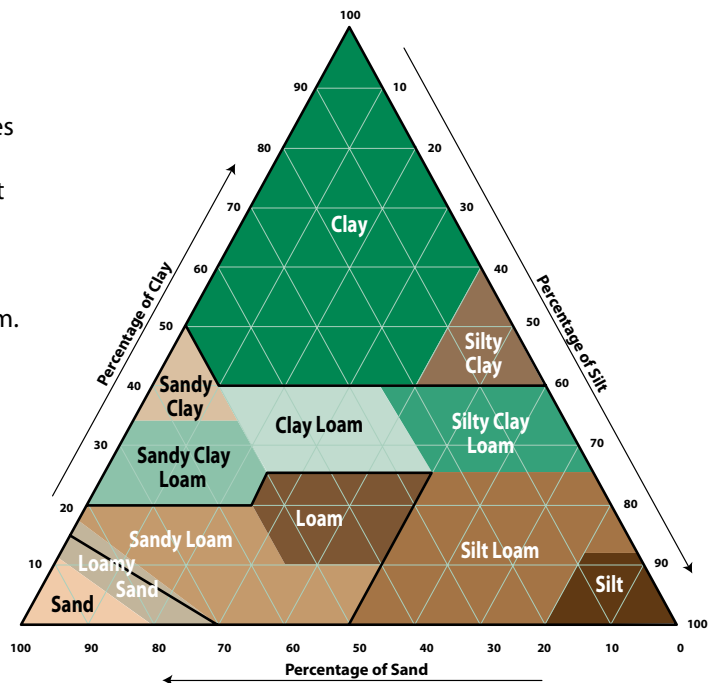
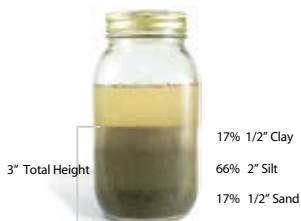

SECTION 3:
DETERMINE DRIPLINE SPECS

CHOOSE THE EMITTER FLOW RATE, SPACING BETWEEN EMITTERS, AND SPACING BETWEEN ROWS

To determine the specification for the emitter flow rate and emitter spacing for the XF Series Dripline on surface, under shrub and ground cover, or sub-surface under turf in table 2, follow the column under the proper soil type for your application to find the emitter flow and emitter spacing.

Table 2 gives recommended emitter flow rates and spacing for three basic soil types. If the soil type is not known, or if there is a good chance that there will be many different types of soil at the site, use the shortest distance between emitters and rows from the table to be sure that the root zone is well irrigated. If there is heavy loam or clay subsoil, these soil types will reduce the downward flow of water in the soil and allow for wider lateral spacing between rows.

TABLE 2: XF SERIES DRIPLINE RECOMMENDATION TABLES

XF Series Dripline Recommendations (English)			
Soil Type	Clay	Loam	Sand
Emitter Flow Rate (gallons per hour)	0.4 gph	0.6 gph	0.9 gph
Emitter Spacing	24"	18"	12"
Dripline Lateral Spacing	18" - 24"	16" - 22"	12" - 18"

XF Series Dripline Recommendations (Metric)			
Soil Type	Clay	Loam	Sand
Emitter Flow Rate (liters per hour)	1.6 l/h	2.3 l/h	3.4 l/h
Emitter Spacing (meters)	0.61	0.45	0.3
Dripline Lateral Spacing (meters)	0.45 - 0.61	0.41 - 0.56	0.3 - 0.45

Note: These are general guidelines, field conditions may require modification to emitter flow rate, emitter spacing and lateral spacing. XF Series Dripline is to be installed at a depth of 4"-6" (10.2-15.24 cm) in sub-surface and groundcover applications. XF Series Dripline may also be installed on-surface under mulch in shrub and groundcover applications.

If you are not quite sure of the soil type, here is a test you can use by squeezing the soil in your hand:

Clay - When dry it forms hard clumps. When damp it is flexible and can be molded into shapes.

Loam - A moderate sand or dirt and very little clay. When dry it breaks easily. When wet it forms a lump.

Sand - Soil particles are loose, sandy grains. When dry it will fall apart when you open your hand. When damp it will form a lump but it will crumble easily when touched.

DRIP ZONE CALCULATOR

By answering just a few short questions, you can quickly see the products we recommend, determine drip zone flow, maximum lateral run length, quantity of dripline required, the application rate and much more. All this from your smartphone or PC.



Drip Zone Calculator

Scan QR Code for easy access or visit our website:
www.rainbird.com/DripZoneCalc

QR Code



SECTION 4: DETERMINE TYPE OF DRIPLINE LAYOUT SUB-SURFACE

END FEED LAYOUT

This Grid layout is primarily used for dense plantings. The layout uses supply headers and flush headers with rows of dripline connected at each end. The supply header and flush header form a continuous loop where all rows of dripline are being supplied from both ends.

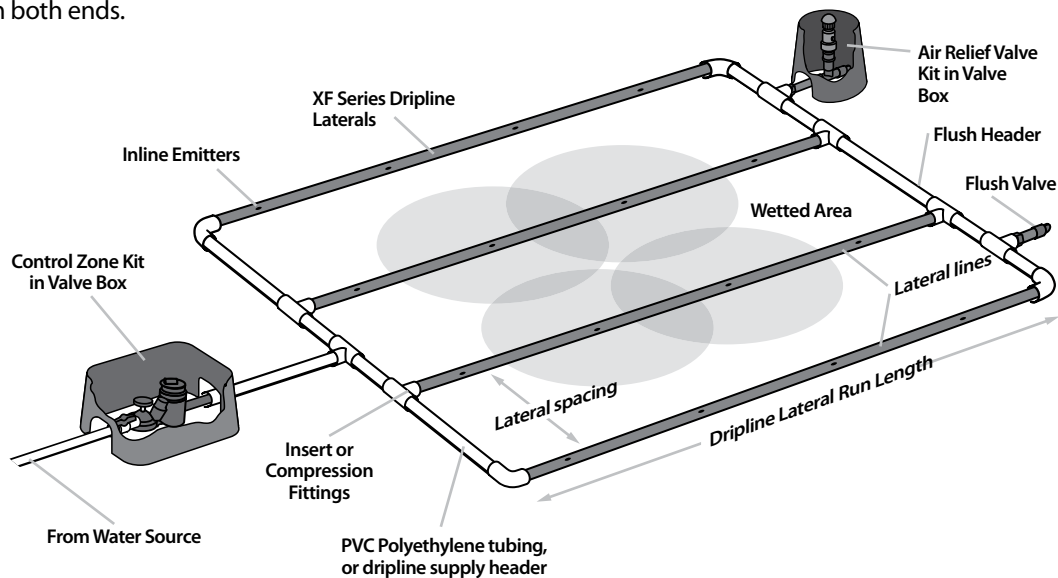

CENTER FEED LAYOUT

Where layout flexibility exists, it is recommended that Center Feed layouts be used. This allows for the most even flow of water through the zone. Center Feed layouts also potentially allow you to increase the size of the zone by providing lateral runs on both sides of the supply header. Center Feed layouts are an excellent option for median strips, road sides, and other homogenous planting zones.

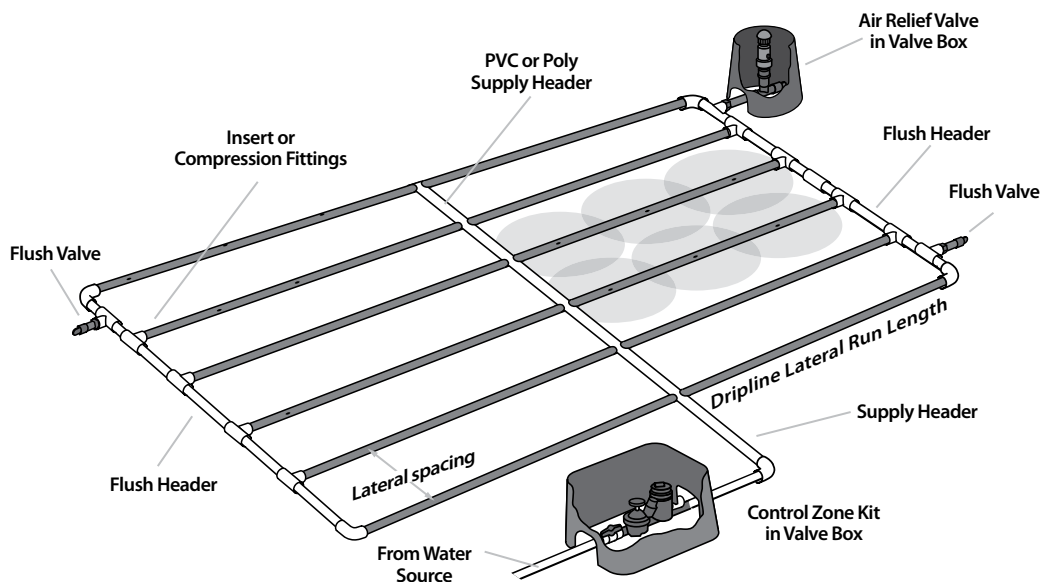

DETERMINE TYPE OF DRIPLINE LAYOUT
ON-SURFACE

QUICK LOOP LAYOUT

The Loop layout is one continuous loop that weaves back and forth throughout the zone in evenly spaced laterals (rows).

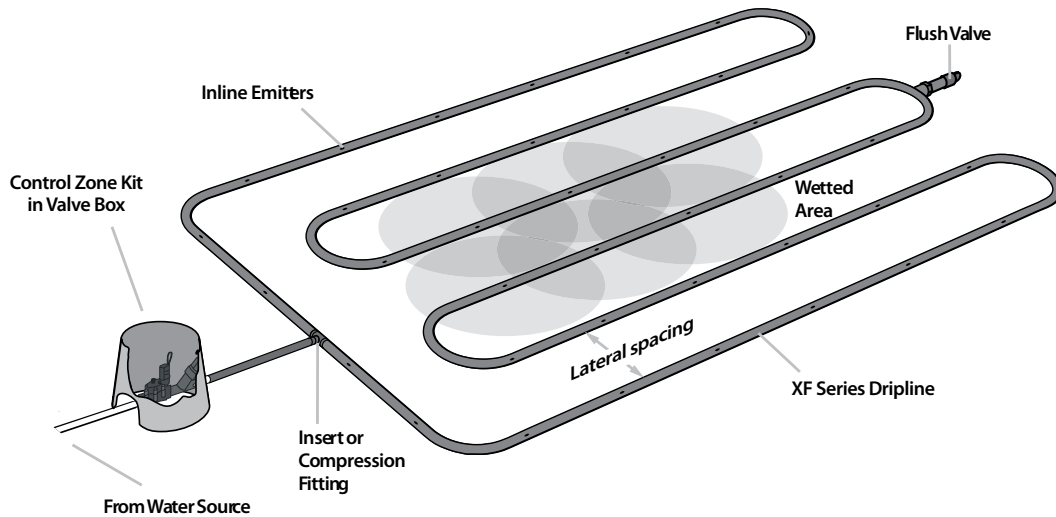

CURVED EDGE LAYOUT

The Curved Edge layout is primarily used for dense planting areas. The layout uses supply and flush headers with rows of dripline connected at the end. The supply and flush header form a continuous loop and the dripline can be attached to the adjacent driplines with "tee" fittings to accommodate curved applications.

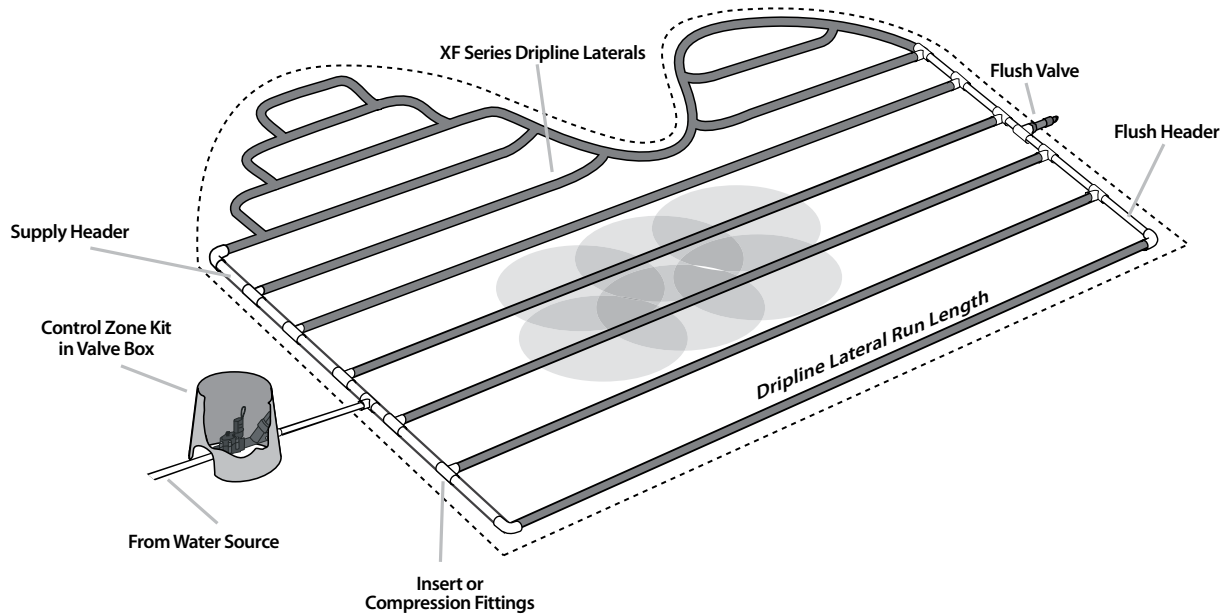

Section 4

OTHER COMMON GRID LAYOUTS

BRANCHING OUT OR JOINING ROW LAYOUTS

When branching out from a supply header with XF Series dripline, maximum lateral run length should be considered. Add up all the “branched out” dripline and check it against the maximum lateral run length listed in Table 6 on page 21.

When joining lateral rows from a supply header, check only the longest lateral against the maximum lateral run length listed in Table 6 on page 21.

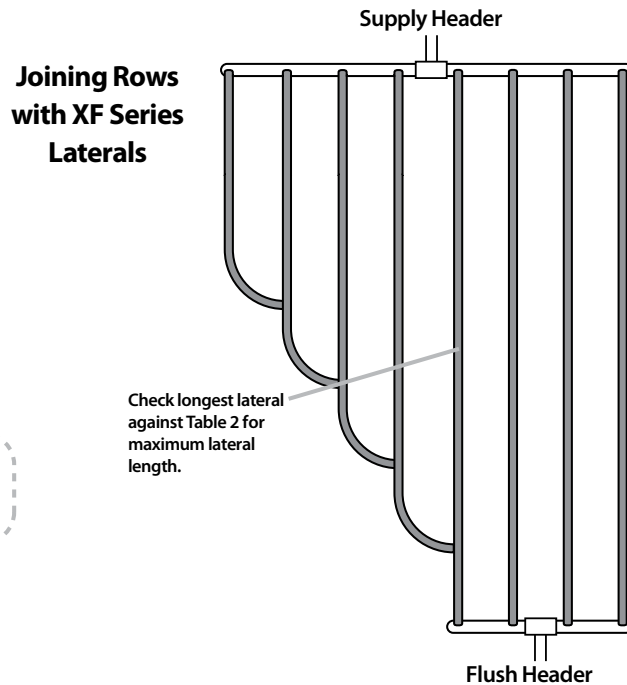
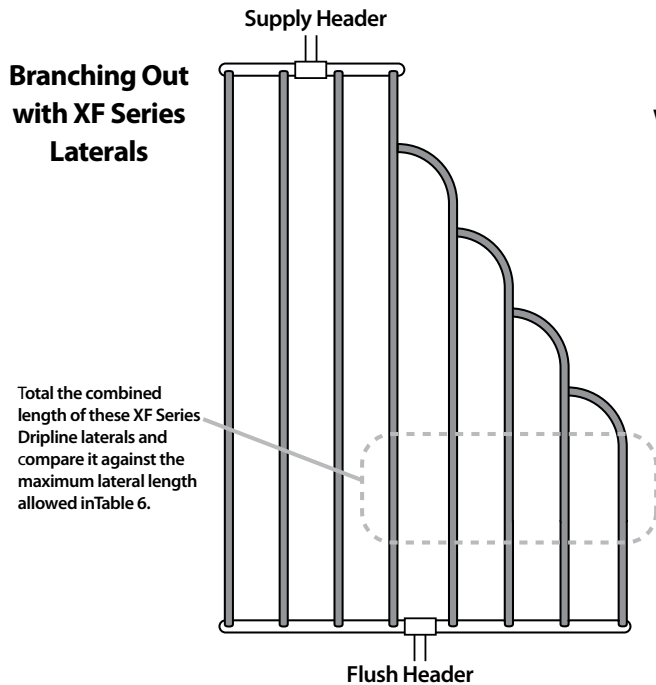

DESIGN CONSIDERATIONS

- Header should be spaced 2" -4" (5cm-10.2 cm) from hardscape or other planting areas
- Headers may be PVC, blank poly tubing or dripline
- Lateral spacing is a design consideration and can be calculated as shown on page 14 in “How to Calculate Equal Lateral (Row) Spacing”
- The lateral run length should not exceed the maximum lateral run length shown in Table 6 on page 21
- When using “Center Feed Layout” the run length should be measured from the supply header to the flush header and should not exceed the maximum run length shown in Table 6 on page 21
- When using “Loop Layout”, because water is split into two separate paths that meet in the middle, the total continuous loop length of dripline should not exceed twice the maximum lateral length
- In sub-surface applications an air vacuum relief valve should be installed at the highest point in the system to avoid back siphoning debris into the emitter
- Flush valves should be installed at the low point in the flush header or at the mid point of the loop layout



SLOPES

- The design of the dripline system should account for slopes on the site since runoff may occur at low points
- Slopes less than 3% do not require special design considerations
- Slopes greater than 3% should increase the dripline spacing by 25% in the bottom 1/3 of the zone
- Dripline should run perpendicular (across) the slope when possible

Section 4

ELEVATION CHANGES - SLOPE LAYOUT

Adjust for slopes

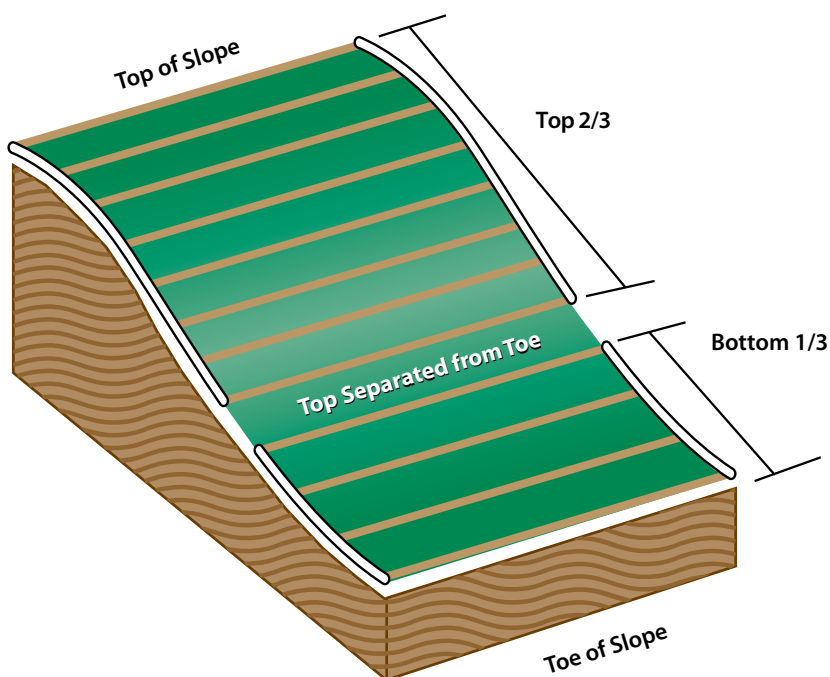

- With steep sloping landscapes, water movement within the soil can be significant
- The area at the bottom 1/3 of the slope should be controlled as a separate zone
- Dripline laterals should run perpendicular (across) the slope whenever possible

DETERMINE LATERAL ROW SPACING

HOW TO CALCULATE EQUAL LATERAL ROW SPACING

A range of lateral row spacing (Ex. 16"-22" / 40.6cm-55.9cm, loam soil) is provided in the example below. To calculate equal lateral row spacing for the design application, you need to know the width of the application and then use the calculation as shown in Example 1.

Example 1: How to Calculate Equal Lateral (Row) Spacing

- Application width = 8' (2.4m)
- Convert into inches: $8' \times 12'' = 96''$
or (Convert into centimeters: $2.43\text{m} \times 100 = 243\text{cm}$)
- It is recommended to space dripline 2" (5cm) from hardscapes and 4" (10.2cm) from separate planting zones

In this example there are hardscapes on each side of the planting zone. Remove the hardscape: spacing on each side from the total width:

$$96'' - (2 \times 2'') = 92'' \quad (243\text{cm} - (2 \times 5\text{cm}) = 233\text{cm})$$

- For loam soil, the range of lateral row spacing is 16"-22" (40.6cm-55.9cm). Choosing 18", calculate the number of spaces between rows: $92'' \div 18'' = 5.1$ ($233\text{cm} \div 0.45\text{m} = 5.1$). Round to get whole spaces. Round up if the decimal is 0.5 or higher, round down if it is less than 0.5. In this case you should round down to 5 whole spaces between rows.
- Calculate the equal lateral row spacing: $92'' \div 5 = 18.4''$ ($233\text{cm} \div 5 = 45\text{cm}$)
- Calculate the number of dripline rows by adding 1 to the number of spaces between rows: $5 + 1 = 6$ dripline rows

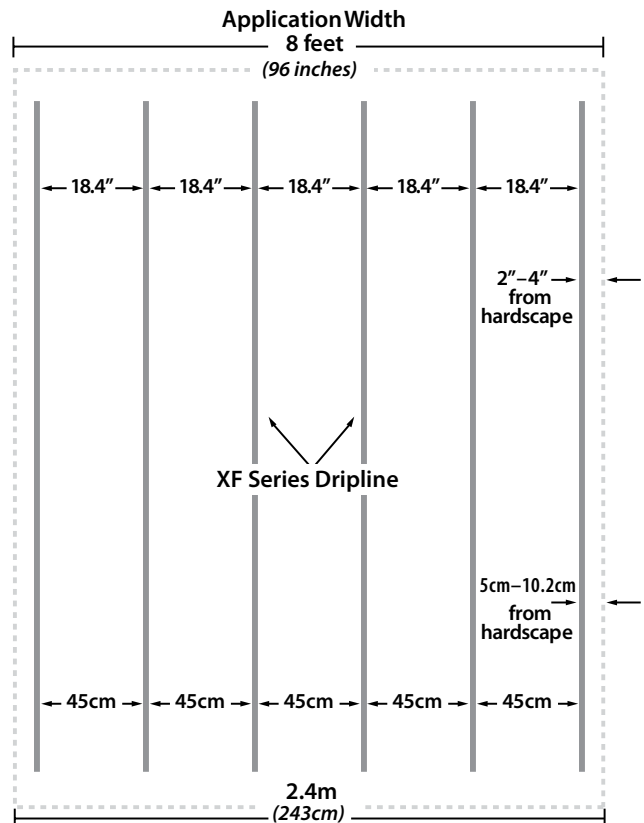

SECTION 5:
ZONE WATER CALCULATIONS

TABLE 3: CALCULATING ZONE WATER REQUIREMENTS

XF Series Dripline Flow (per 100 feet)						
Emitter Spacing	0.4 GPH Emitter		0.6 GPH Emitter		0.9 GPH Emitter	
Inches	GPH	GPM	GPH	GPM	GPH	GPM
12"	42	0.70	61	1.02	92	1.53
18"	28	0.47	41	0.68	61	1.02
24"	21	0.35	31	0.52	46	0.77

XF Series Dripline Flow (per 100 Meters)						
Emitter Spacing	1.6 L/Hr Emitter		2.3 L/Hr Emitter		3.4 L/Hr Emitter	
Centimeters	L/Hr	L/Min	L/Hr	L/Min	L/Hr	L/Min
30cm	533	8.89	767	12.78	1133	18.89
46cm	348	5.80	500	8.33	739	12.32
61cm	262	4.37	377	6.28	557	9.29

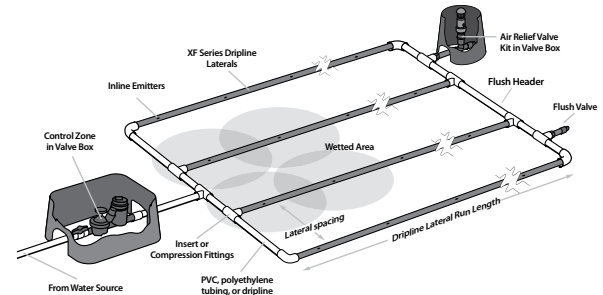

Note: This example represents approximately 650' of dripline.

After the dripline layout design is complete, you will need to identify total zone flow. This is used to help select mainline, supply and flush headers, and control zone kit (valve, filter, and regulator).

- Calculating zone water requirements can be done by adding up the total length of dripline in the zone. Convert the total dripline length to hundreds of feet (650 feet would be 6.5 in hundreds of feet).
- Multiply total dripline length in hundreds of feet by the flow per 100 feet for your specified dripline. This can be found in Table 3. To read the table, select the emitter flow rate in the row across the top (0.4 GPH, 0.6 GPH, or 0.9 GPH / 1.6 L/Hr, 2.3, L/Hr, or 3.4 L/Hr) and then select the emitter spacing in the left column (12", 18" or 24" / 0.30m, 0.46m or 0.61m). Follow emitter flow rate down and emitter spacing across to find the flow per 100 feet for the XF Series dripline specified.
- For example, for a zone that has 650 feet of 0.9 GPH (3.4 L/Hr) emitters and 18" (0.46m) emitter spacing, the calculation would be 6.50 x 1.02 gpm = 6.6 gpm for the zone.
- Supply lines and headers should be sized to provide the flow to the zone without exceeding 5 feet per second velocity. This can be done using the zone water requirement and referencing information on the appropriate piping located at www.rainbird.com/reference or in the back reference section in the Rain Bird catalog.

TABLE 4: DETERMINE MAXIMUM FLOW PER ZONE

Maximum Flow Per Zone (English)					
Sch. 40 PVC Header Size	Max. Flow* GPM	PSI Loss**	Poly Pipe Header Size	Max. Flow* GPM	PSI Loss**
1/2"	4.7 GPM	7.7 PSI	1/2"	4.7 GPM	8.8 PSI
3/4"	8.3 GPM	5.6 PSI	3/4"	8.3 GPM	6.3 PSI
1"	13.5 GPM	4.2 PSI	1"	13.5 GPM	4.8 PSI
1 1/4"	23.1 GPM	3.1 PSI	1 1/4"	23.1 GPM	3.1 PSI
1 1/2"	33.9 GPM	2.9 PSI	1 1/2"	33.9 GPM	2.9 PSI
2"	52.4 GPM	1.9 PSI	2"	52.4 GPM	1.9 PSI

* Based on maximum velocity of 5' per second
** Per 100' of tubing

Maximum Flow Per Zone (Metric)					
Sch. 40 PVC Header Size	Max. Flow* LPM	Bar Loss**	Poly Pipe Header Size	Max. Flow* LPM	Bar Loss**
1.27 cm	17.8	0.53	1.27 cm	17.8	0.61
1.91 cm	31.4	0.39	1.91 cm	31.4	0.43
2.54 cm	51.1	0.29	2.54 cm	51.1	0.33
3.18 cm	87.4	0.21	3.18 cm	87.4	0.22
3.81 cm	128.3	0.20	3.81 cm	128.3	0.20
5.08 cm	198.4	0.13	5.08 cm	198.4	0.13

* Based on maximum velocity of 1.52 m per second
** Per 30.5 meters of tubing

CALCULATING APPLICATION RATES

APPLICATION RATE

The application rate is the rate that XF Series Dripline applies water to the soil. This is used to determine run times for the zone based on the plant watering requirements. Table 5 is provided to make it easy to determine application rates for every model of XF Series Dripline when using common row spacing (12"-24" / 30cm-61cm). The table is divided into three sections, a 0.4 GPH (1.6 l/hr) emitter flow section, a 0.6 GPH (2.3 l/hr) emitter flow section and a 0.9 GPH (3.4 l/hr) emitter flow section. Go to the section for the specified emitter flow rate and find in the left hand column the specified emitter spacing. Next, find the lateral row spacing across the top of the table. Follow the lateral row spacing column down and the emitter spacing row across until the two meet. This is the application rate in inches per hour (centimeters per hour). For example, a 0.6 GPH (2.3 l/hr) emitter flow rate with 18" (46cm) lateral row spacing and 18" (46cm) emitter spacing has an application rate of 0.43 (1.09cm/hr) inches per hour.

TABLE 5: APPLICATION RATE

Lateral Row Spacing (in Inches)											
Emitter Spacing	12"	13"	14"	15"	16"	17"	18"	19"	20"	22"	24"
0.4 GPH Emitter Flow (Inches per hour)											
12"	0.67	0.62	0.58	0.54	0.51	0.48	0.45	0.43	0.40	0.37	0.34
18"	0.45	0.41	0.39	0.36	0.34	0.32	0.30	0.28	0.27	0.25	0.22
24"	0.34	0.31	0.29	0.27	0.25	0.24	0.22	0.21	0.20	0.18	0.17
0.6 GPH Emitter Flow (Inches per hour)											
12"	0.96	0.89	0.83	0.77	0.72	0.68	0.64	0.61	0.58	0.53	0.48
18"	0.64	0.59	0.55	0.51	0.48	0.45	0.43	0.41	0.39	0.35	0.32
24"	0.48	0.44	0.41	0.39	0.36	0.34	0.32	0.30	0.29	0.26	0.24
0.9 GPH Emitter Flow (Inches per hour)											
12"	1.44	1.33	1.24	1.16	1.08	1.02	0.96	0.91	0.87	0.79	0.72
18"	0.96	0.89	0.83	0.77	0.72	0.68	0.64	0.61	0.58	0.53	0.48
24"	0.72	0.67	0.62	0.58	0.54	0.51	0.48	0.46	0.43	0.39	0.36

Lateral Row Spacing (in Centimeters)											
Emitter Spacing	30	33	36	38	41	43	46	48	51	56	61
1.6 LPH Emitter Flow (cm per hr)											
30cm	1.78	1.62	1.48	1.40	1.30	1.24	1.16	1.11	1.05	0.95	0.87
46cm	1.16	1.05	0.97	0.92	0.85	0.81	0.76	0.72	0.68	0.62	0.57
61cm	0.87	0.79	0.73	0.69	0.64	0.61	0.57	0.55	0.51	0.47	0.43
2.3 LPH Emitter Flow (cm per hr)											
30cm	2.44	2.26	2.11	1.96	1.86	1.73	1.63	1.55	1.47	1.35	1.22
46cm	1.63	1.50	1.40	1.30	1.22	1.14	1.09	1.02	0.99	0.89	0.81
61cm	1.22	1.12	1.04	0.99	0.91	0.86	0.81	0.76	0.74	0.66	0.61
3.4 LPH Emitter Flow (cm per hr)											
30cm	3.66	3.38	3.15	2.95	2.74	2.59	2.44	2.31	2.21	2.01	1.83
46cm	2.44	2.26	2.11	1.96	1.83	1.73	1.63	1.55	1.47	1.35	1.22
61cm	1.83	1.70	1.57	1.47	1.37	1.30	1.22	1.17	1.09	0.99	0.91

At this point the emitter flow rate and spacing between emitters and rows has been selected. Use the tables to determine the overall water application rate for the landscape area.

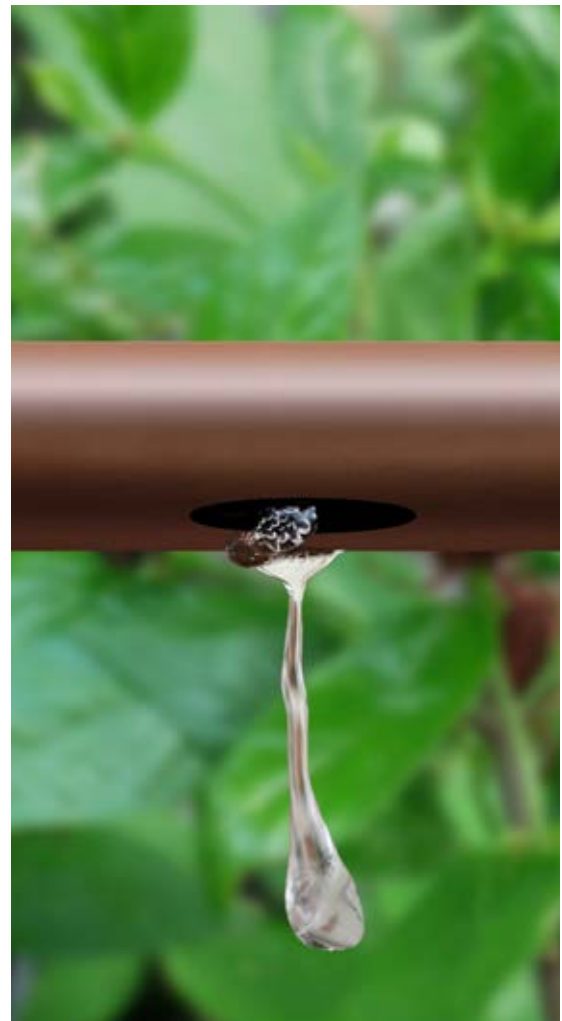

CALCULATIONS FOR DRIPLINE IRRIGATION

HOW DO I DETERMINE THE APPLICATION RATE?

$$\frac{(Emitter Flow Rate in GPH) \times 231.1}{(Lateral Row Spacing in Inches) \times (Emitter Spacing in Inches)}$$

Example:

Emitter Flow Rate	0.6 GPH
Emitter Spacing	12 inches
Lateral Row Spacing	18 inches

$$\frac{0.6 \times 231.1}{12 \times 18} = 0.64 \text{ inches/hour}$$

$$\frac{(Emitter Flow Rate in l/hr) \times 1000}{(Lateral Row Spacing in cm) \times (Emitter Spacing in cm)}$$

Example:

Emitter Flow Rate	2.3 l/hr
Emitter Spacing	30 cm
Lateral Row Spacing	41 cm

$$\frac{2.3 \times 1,000}{30 \times 41} = 1.86 \text{ cm/hr}$$

WHAT IS THE TOTAL FLOW WITHIN THE DRIP ZONE?

$$\frac{(Irrigated Area in Sq Ft) \times (Emitter Flow in GPH) \times 2.4}{(Lateral Row Spacing in Inches) \times (Emitter Spacing in Inches)}$$

Example:

Irrigated Area	2500 Sq Ft
Emitter Flow Rate	0.6 GPH
Emitter Spacing	18 inches
Lateral Row Spacing	18 inches

$$\frac{2500 \times 0.6 \times 2.4}{18 \times 18} = 11.11 \text{ GPM}$$

$$\frac{(Irrigated Area in Sq Meters) \times (Emitter Flow in l/hr) \times 166.7}{(Lateral Row Spacing in cm) \times (Emitter Spacing in cm)}$$

Example:

Irrigated Area	800 Sq Meters
Emitter Flow Rate	3.4 l/hr
Emitter Spacing	46 cm
Lateral Row Spacing	48 cm

$$\frac{800 \times 3.41 \times 166.7}{46 \times 48} = 206 \text{ l/min}$$

HOW MUCH DRIPLINE DO I NEED BASED ON SIZE OF IRRIGATED AREA?

$$\frac{(Area in Sq Ft) \times 12}{Lateral Row Spacing in Inches}$$

Example:

Irrigated Area	2165 Sq Ft
Lateral Row Spacing	18 inches

$$\frac{2165 \times 12}{18} = 1443 \text{ feet of dripline needed}$$

$$\frac{(Area in Sq Meters) \times 100}{Lateral Row Spacing in cm}$$

Example:

Irrigated Area	425 Sq Meters
Lateral Row Spacing	36 cm

$$\frac{425 \times 100}{36} = 1180 \text{ meters of dripline needed}$$

HOW MANY FEET OF DRIPLINE CAN I USE IF I KNOW THE AVAILABLE FLOW?

$$\frac{Flow Available}{Flow per 100 Foot Length} \times 100 = Maximum Feet$$

Obtain "Flow per 100 Feet" from Table 3 on page 15
 Example:
 You have 11 GPM available flow
 You want to use 0.6 GPH emitters on 18" spacing

$$\frac{11 \text{ GPM}}{0.68 \text{ GPM}} \times 100 \text{ feet} = 1618 \text{ maximum feet of dripline}$$

$$\frac{Flow Available}{Flow per 100 Meter Length} \times 100 = Maximum Meters$$

Obtain "Flow per 100 Meters" from Table 3 on page 15
 Example:
 You have 130 l/min available flow
 You want to use 2.3 l/hr emitters on 0.46 meter spacing

$$\frac{130 \text{ l/min}}{2.31 \text{ l/hr}} \times 100 \text{ meters} = 5628 \text{ maximum feet of dripline}$$

FORMULAS FOR XF SERIES DRIPLINE

PLANT WATER REQUIREMENT FOR A DENSE PLANTING SCHEME

The water requirement for a densely planted hydro-zone is measured in inches per day.

$$\text{Plant Water Requirement} = \text{PET} \times K_c$$

PET

The amount of water that is used by the combination of evaporation from the soil and transpiration from plants growing in the soil. PET is generally expressed in inches per day.

K_c

K_c is an adjustment factor to PET that accounts for the needs of a specific plant in specific growing conditions. It is also known as the “crop coefficient” or the “plant factor”.

$$K_c = \text{Species Factor} \times \text{Density Factor} \times \text{Microclimate Factor}$$

SYSTEM RUN TIME





The formula for system run time for dense plants is based on a measurement of flow in inches per day.

$$\text{System Run Time (Hours)} = \frac{\text{Plant Water Requirement (Inches per day)}}{\text{Application Rate} \times \text{Application Efficiency}}$$

More detailed information on calculating Plant Water Requirement and System Run Time can be found in the Low-Volume Landscape Irrigation Design Manual; Chapters 4 & 5. This manual is only available for download on our website.

<http://www.rainbird.com/dripline>

SECTION 6:
APPLICATION OVERVIEW

LANDSCAPE CHALLENGES		 ON-SURFACE	 SLOPES	 SUB-SURFACE
	Product	1/4" Dripline	XFD Dripline	XFCV Dripline
Sloped Areas	X	X	X	X
Shrub & Ground Cover Beds	X	X	X	X
Container Planters	X	X	X	X
High Traffic Areas	X	X	X	X
Curved Landscapes	X	X	X	X
Narrow Landscaped Areas	X	X	X	X
Areas of Vandalism	X	X	X	X
Median / Parking Islands Shrub & ground Cover		X	X	X
High Wind Conditions		X	X	X
Turf (grass)				X
Sub-Surface Applications				X
Narrow Turf Areas				X
Large Turf Areas /Athletic Fields				X
Median / Parking Islands Turf			X	X
Sloped to 8'			X	



XFD DRIPLINE

- Greater flexibility
- Longer lateral runs
- Exceptional durability
- Available in purple for non-potable water



XFS DRIPLINE

- Copper Shield™ Technology
- Trifluralin-free emitter protection
- Exceptional durability
- Available in purple for non-potable water



XFCV DRIPLINE

- Heavy-Duty 3.5 psi Check Valve
- Slopes to 8'
- Greater flexibility
- Longer lateral runs
- Exceptional durability
- Available in purple for non-potable water



1/4" DRIPLINE

- In-line emitters
- Perfect for pots and small beds
- Easy installation

XF DRIPLINE FOR ON-SURFACE APPLICATIONS



ON-SURFACE

RAIN BIRD FLAT EMITTER TECHNOLOGY

Superior Design for Superior Reliability

State-of-the-art assembly technology helps resist bending and collapsing under extreme field use

Chemical-resistant silicone diaphragm for longer life

Self-flushing emitter design clears grit and debris to provide a reliable supply of clean water to plant roots

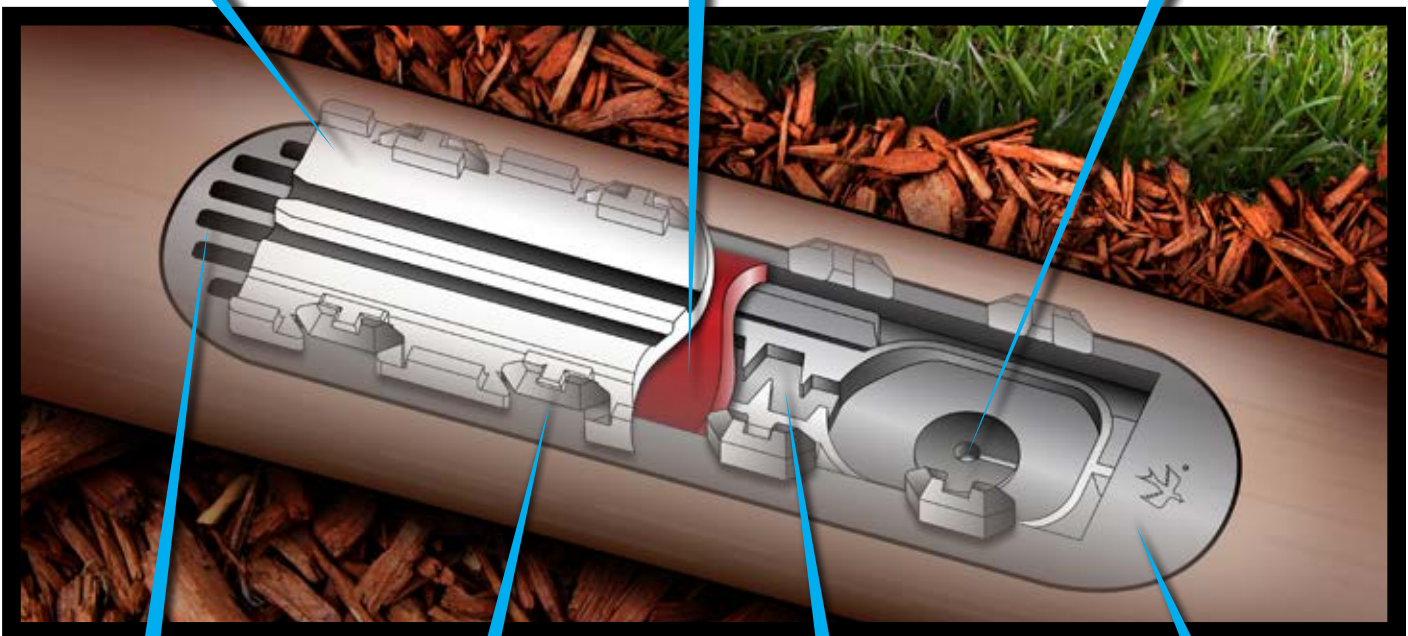

Larger inlet holes let debris pass instead of plugging emitter filter

Reinforcing members make emitter structurally more robust

Widest emitter flow channel in the industry let debris pass instead of internally plugging emitter

Low-profile design draws cleanest available water and reduces friction loss

ADDITIONAL FEATURES



XFD Dripline Coil

- Unique, extra-flexible tubing material allows for tighter turns with fewer elbows for fast and easy installation
- Dual-layered tubing (brown over black or purple over black) provides unmatched resistance to chemicals, UV damage and algae growth
- Low-profile emitter design results in reduced friction loss, allowing longer maximum lateral runs and more cost-effective system designs
- Continuous flushing action and wide flow path ensure that water will keep flowing, thus minimizing maintenance, and saving you time and money

XFD DRIPLINE

Applications

Rain Bird® XFD Dripline is the most flexible, kink-resistant tubing available in the marketplace today, making it ideal for irrigating areas where traditional drip tubing is difficult to install. XFD Dripline is perfect for small, narrow and tight planting areas, as well as areas with tight curves or many switchbacks. Design with XFD dripline is easy as it accepts 17mm insert fittings, Rain Bird Easy Fit Compression fittings and LOC fittings.

XFD Dripline is **simple, reliable** and **durable**.

Features

Simple

- Unique material offers significantly greater flexibility and kink-resistance for fast, easy installation
- Greater flexibility assures design capability for tight curves and spaces
- Rain Bird's self-dispensing coils make it easy to use exactly what is needed while keeping the balance of the coil ready for the next job
- Accepts Rain Bird Easy Fit Compression Fittings, XF Dripline Insert Fittings, Rain Bird Easy Fit Compression fittings and LOC fittings
- Variety of flow rates, spacings, and coil lengths provides design flexibility for many non-turfgrass applications

Reliable

- Pressure-compensating emitter design provides consistent flow over the entire lateral length, ensuring higher uniformity for increased reliability in the pressure range of 8.5 to 60 psi

Durable

- Dual-layered tubing (brown over black or purple over black) provides unmatched resistance to chemicals, algae growth and UV damage

Operating Range

- Pressure: 8.5 to 60 psi (.58 to 4.14 bar)
- Flow rates: 0.4, 0.6, and 0.9 gph (1.6, 2.3 l/hr and 3.4 l/hr)
- Temperature:
 - Water: Up to 100°F (37.8° C)
 - Ambient: Up to 125°F (51.7° C)
- Required Filtration: 120 mesh

Specifications

- OD: 0.634" (16mm)
- ID: 0.536" (13.61mm)
- Thickness: 0.049" (1.25mm)
- Spacing: 12", 18", 24" (30.5 cm, 45.7 cm, 61.0 cm)
- Available in 100', and 500' (30.5 m, and 152.4 m) coils

The flexible polyethylene tubing shall have factory-installed, pressure-compensating, inline emitters installed every 12, 18, or 24 inches. The flow rate from each installed inline emitter shall be 0.4, 0.6 or 0.9 gallons per hour when inlet pressure is between 8.5 and 60 psi.

The inline emitter diaphragm shall have a pressure-regulating diaphragm with a spring action, allowing it to self-rinse if there is a plug at the outlet hole.

The inline emitter inlet shall be raised off the inside tube wall to minimize dirt intrusion. The XF Series Dripline inline tubing shall be manufactured by Rain Bird Corporation, Azusa, California.

Models

- | | | |
|-------------------------|-------------------------|-------------------------|
| 0.4 GPH Emitters | 0.6 GPH Emitters | 0.9 GPH Emitters |
| • XFD-04-12-100 | • XFD-06-12-100 | • XFD-09-12-100 |
| • XFD-04-12-500 | • XFD-06-12-500 | • XFD-09-12-500 |
| • XFD-04-18-100 | • XFD-06-12-500 | • XFD-09-12-500 |
| • XFD-04-18-500 | • XFD-06-18-100 | • XFD-09-18-100 |
| | • XFD-06-18-250 | • XFD-09-18-250 |
| | • XFD-06-18-500 | • XFD-09-18-500 |
| | | • XFD-09-24-500 |

Non-Potable (Purple) Dripline

- XFDP-06-12-500
- XFDP-09-12-500
- XFDP-06-18-500
- XFDP-09-18-500



XFD Dripline offers increased flexibility for easy installation.

TABLE 6: LATERAL RUN LENGTHS

XFD Dripline Maximum Lateral Lengths (Feet)								
	12" Spacing			18" Spacing			24" Spacing	
PSI	0.4GPH	0.6 GPH	0.9 GPH	0.4 GPH	0.6 GPH	0.9 GPH	0.6 GPH	0.9 GPH
15	352	273	155	374	314	250	424	322
20	399	318	169	417	353	294	508	368
30	447	360	230	481	413	350	586	414
40	488	395	255	530	465	402	652	474
50	505	417	285	610	528	420	720	488
60*	573	460	290	734	596	455	780	514

XFD Dripline Maximum Lateral Lengths (Meters)								
	30.5 cm Spacing			45.7 cm Spacing			61.0 cm Spacing	
Bar	1.6l/h	2.3l/h	3.4l/h	1.5 l/h	2.3l/h	3.4l/h	2.3 l/h	3.4l/h
1.03	107.2	83.2	47.2	114	95.7	76.2	129.2	98.2
1.38	121.6	96.9	51.5	127.1	107.6	89.6	154.8	112.2
2.07	136.2	109.7	70.1	146.6	125.9	106.7	178.6	123.2
2.76	148.7	120.4	77.7	161.5	141.7	122.5	198.7	144.5
3.45	153.9	127.1	86.9	185.9	160.9	128.0	219.5	148.7
4.14*	174.6	140.2	88.4	223.7	181.7	138.7	237.7	156.7

*When using 17mm insert fittings with design pressure over 50 psi (3.5 bar), it is recommended that stainless steel clamps be installed on each fitting.

BEST ON-SURFACE APPLICATIONS

- Shrub and groundcover beds
- Seasonal color beds
- Curved landscapes
- Small confined areas
- Areas where overspray is undesirable such as buildings, windows, and fences
- Narrow landscapes
- Areas affected by wind and evaporation

XFD DRIPLINE WHERE IS IT USED?



Flower beds



Eliminate overspray on buildings



Narrow landscapes

With XFCV's built-in **3.5 PSI CHECK VALVE**, all lines are kept charged and 8 feet of water is held back



The check valve also helps to prevent over-watering at the low-point in the zone, avoiding puddling from water draining from the dripline.

XFCV DRIPLINE FOR ELEVATED APPLICATIONS



SLOPES

Elevated Performance

Keeps dripline charged with water even with elevation changes to 8 feet.

Conserves Water

Prevents puddling and water loss at the low point of the dripline.

Low-Profile Flat Emitter



Rain Bird's low-profile flat emitter design reduces in-line pressure loss, allowing longer lateral runs, simplifying design and reducing installation time.

Greater Flexibility



Rain Bird's proprietary blend provides industry-leading flexibility allowing for tighter turns with fewer elbows for fast and easy installation.

LEED Compliant



Contains at least 20% post consumer recycled polyethylene which qualifies for LEED credit 4.2.

Applications

Rain Bird® XFCV Dripline with a heavy-duty 3.5 psi check valve for on-surface applications adds a valuable member to the Rain Bird XF Series of Dripline. Rain Bird's XFCV is the most effective dripline in the industry addressing applications where elevation changes exist. Rain Bird's patent-pending check valve keeps the dripline charged in elevation changes to 8 feet, Rain Bird's XFCV can be used where no other dripline will work. Keeping water in the dripline at all times helps for better uniformity of irrigating the plants throughout the entire zone. The check valve also helps to prevent over-watering at the low-point in the zone, avoiding puddling and water draining from the dripline.

Features

Simple

- Rain Bird's patent-pending 3.5 psi check valve technology keeps the dripline charged with water at all times, increasing uniformity of watering, and conserves water by eliminating the need to recharge the line at the beginning of each watering cycle

- Through the use of a proprietary tubing material, the XFCV Dripline with heavy-duty check valve is the most flexible dripline tubing in the industry, making it the easiest dripline to design with and install

- It Accepts Rain Bird Easy Fit Compression Fittings, XF Dripline Barbed Insert Fittings and other 17 mm barbed insert fittings

- Rain Bird's low-profile emitter design reduces in-line pressure loss, allowing longer lateral runs, simplifying design and reducing installation time

- Variety of emitter flow rates, emitter spacing and coil lengths provide design flexibility for on-surface areas with or without elevation changes

Made with Recycled Content

- All Rain Bird XF Dripline (XFD, XFS, XFCV) qualify for LEED credit 4.2 because they contain at least 20% Polyethylene post consumer recycled material by cost. These come in an assortment of coil sizes, flow rates and emitter spacing.

Reliable

- The pressure-compensating emitter design provides a consistent flow over the entire lateral length ensuring higher uniformity for increased reliability in pressure ranges of 20 to 60 psi

Durable

- Dual-layered tubing (brown over black) provides unmatched resistance to chemicals, algae growth and UV damage

Grit Tolerant

- Rain Bird's proprietary emitter design resists clogging by use of an extra-wide flow path combined with self-flushing action

Operating Range

- Opening Pressure:** 14.5 psi (1,0 bar)
- Pressure:** 20 to 60 psi (1,38 to 4,14 bar)
- Flow rates:** 0.6 and 0.9 gph (2,31 l/hr and 3,4 l/hr)
- Temperature:**
Water: Up to 100°F (37,8° C)
Ambient: Up to 125°F (51,7° C)

Specifications

- OD:** 0.634"
- ID:** 0.536"
- Thickness:** 0.049"
- 12" & 18" (30,5 cm & 45,7 cm) spacing**
- Coil lengths:** 100' and 500' (30,5 m, and 152,4 m) coils
- Coil Color:** Brown

Models

- XFCV0612100
- XFCV0612500
- XFCV0618100
- XFCV0618500
- XFCV0912100
- XFCV0912500
- XFCV0918100
- XFCV0918500

TABLE 7: LATERAL RUN LENGTHS

XFCV Dripline Maximum Lateral Lengths (Feet)				
PSI	12" Spacing		18" Spacing	
	0.6 GPH	0.9 GPH	0.6 GPH	0.9 GPH
20	192	136	254	215
30	289	205	402	337
40	350	248	498	416
50	397	281	573	477
60*	436	309	637	529

* When using 17mm insert fittings with design pressure over 50psi, it is recommended that stainless steel clamps be installed on each fitting.

XFCV Dripline Maximum Lateral Lengths (Meters)				
Bar	30,5cm Spacing		45,7cm Spacing	
	2.3 L/h	3.4 L/h	2.3 L/h	3.4 L/hr
1,38	58,5	41,5	77,4	65,5
2,07	88	62,5	122,5	102,7
2,76	107	75,6	151,8	126,8
3,45	121	85,6	174,7	145,4
4,14*	133	94,2	194,2	161,2

* When using 17mm insert fittings with design pressure over 3.5 bar, it is recommended that stainless steel clamps be installed on each fitting.



XFS Sub-surface Dripline, winner of the "Best New Product" for 2010 by the Irrigation Association

XFS DRIPLINE FOR SUB-SURFACE APPLICATIONS

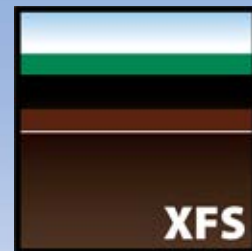

XFS
SUB-SURFACE

Rain Bird's XFS Sub-surface Dripline with Copper Shield™ Technology is the first sub-surface dripline to effectively protect the emitter from root intrusion without the use of Trifluralin. Copper Shield™ Technology is the environmentally-responsible alternative to chemical inhibitors.

XFS can be used on turf grass or shrub and groundcover areas. It's also perfect for small, narrow and tight planting areas, as well as areas with tight curves or many switchbacks. It accepts Rain Bird Easy Fit Compression Fittings, XF Dripline Barbed Insert Fittings and other 17 mm barbed insert fittings.



WATER EFFICIENT

Expands use of sub-surface irrigation which can be 90% efficient, resulting in up to 70% water savings.

RELIABLE

Grit tolerant emitter resists clogging by use of an extra-wide flow path combined with a self-flushing action.

INNOVATIVE

Ground-breaking solution to root intrusion with patent-pending Copper Shield™ Technology.

ENVIRONMENTALLY RESPONSIBLE

Environmentally responsible solution to root intrusion without the use of harsh chemicals.



Applications

Rain Bird® XFS Dripline with Copper Shield™ Technology for subsurface drip irrigation is the latest innovation in the Rain Bird Xerigation® Family. Rain Bird's patent-pending Copper Shield™ protects the emitter from root intrusion, creating a long-lasting, low-maintenance, subsurface drip irrigation system for use under turf grass or shrub and groundcover areas. XFS Dripline with Copper Shield™ is perfect for small, narrow and tight planting areas, as well as areas with tight curves or turf of any size. It accepts Rain Bird Easy Fit Compression Fittings, XF Dripline Barbed Insert Fittings and other 17 mm barbed insert fittings.

Features

Simple

- Rain Bird's patent pending Copper Shield™ Technology protects the emitter from root intrusion without requiring EPA-approved handling procedures, unlike some manufacturers who use harsh chemicals or treated filters to protect the emitter from root intrusion
- Through the use of a proprietary tubing material, XFS Dripline with Copper Shield™ is the most flexible dripline tubing in the industry, making it the easiest subsurface dripline to design with and install
- It accepts Rain Bird Easy Fit Compression Fittings, XF Dripline Barbed Insert Fittings and other 17 mm barbed insert fittings
- Rain Bird's low-profile flat emitter design reduces in-line pressure loss, allowing longer lateral runs, simplifying design and reducing installation time
- Variety of emitter flow rates, emitter spacing and coil lengths provides design flexibility for either sub-surface turf grass or sub-surface shrub and groundcover applications

Reliable

- XFS with Copper Shield™ emitters are protected from root intrusion by Rain Bird's patent-pending Copper Shield™ Technology, resulting in a system that does not require maintenance or replacement of chemicals to prevent root intrusion
- The pressure-compensating emitter design provides consistent flow over the entire lateral length, ensuring higher uniformity, for increased reliability in the pressure range of 8.5 to 60 psi

Durable

- Dual-layered tubing (copper color over black) provides unmatched resistance to chemicals, algae growth and UV damage.
- Grit Tolerant: Rain Bird's proprietary emitter design resists clogging by use of an extra-wide flow path combined with a self-flushing action.

Operating Range

- Pressure: 8.5 to 60 psi (.58 to 4.14 bar)
- Flow rates: 0.4 gph, 0.6, and 0.9 gph (1.6 l/h, 2.3 l/hr, and 3.4 l/hr)
- Temperature:
 - Water: Up to 100°F (37.8° C)
 - Ambient: Up to 125°F (51.7° C)
- Required Filtration: 120 mesh

Specifications

- OD: 0.634" (16mm)
 - ID: 0.536" (13.61mm)
 - Thickness: 0.049" (1.25mm)
- (continued)**
- 12", 18", 24"
(30.5 cm, 45.7 cm, 61.0 cm) spacing

XFS DRIPLINE
WITH COPPER SHIELD™
TECHNOLOGY

- Available in 100', and 500' (30.5 m, and 152.4 m) coils
- Coil Color: Copper or purple

Models

- XFS-04-12-100
- XFS-04-12-500
- XFS-04-18-100
- XFS-04-18-500
- XFS-06-12-100
- XFS-06-12-500
- XFS-06-18-100
- XFS-06-18-500
- XFS-06-24-500
- XFS-09-12-100
- XFS-09-12-500
- XFS-09-18-500

Non Potable (Purple)

- XFSP-04-12-500
- XFSP-04-18-500
- XFSP-06-12-500
- XFSP-06-18-500
- XFSP-09-12-500
- XFSP-09-18-500



TABLE 8: LATERAL RUN LENGTHS

XFS Dripline Maximum Lateral Lengths (Feet)								
PSI	12" Spacing			18" Spacing			24" Spacing	
	0.4 GPH	0.6 GPH	0.9 GPH	0.4 GPH	0.6 GPH	0.9 GPH	0.6 GPH	0.9 GPH
15	352	273	155	374	314	250	424	322
20	399	318	169	417	353	294	508	368
30	447	360	230	481	413	350	586	414
40	488	395	255	530	465	402	652	474
50	505	417	285	610	528	420	720	488
60*	573	460	290	734	596	455	780	514

* When using 17mm insert fittings with design pressure over 50psi, it is recommended that stainless steel clamps be installed on each fitting.

XFS Dripline Maximum Lateral Lengths (Meters)								
Bar	30.5cm Spacing			45.7cm Spacing			61.0cm Spacing	
	1.6L/h	2.3L/h	3.4 L/h	1.6L/h	2.3L/h	3.4L/h	2.3L/h	3.4L/h
1.03	107.2	83.2	47.2	114	95.7	76.2	129.2	98.2
1.38	121.6	96.9	51.5	127.1	107.6	89.6	154.8	112.2
2.07	136.2	109.7	70.1	146.6	125.9	106.7	178.6	123.2
2.76	148.7	120.4	77.7	161.5	141.7	122.5	198.7	144.5
3.45	153.9	127.1	86.9	185.9	160.9	128.0	219.5	148.7
4.14*	174.6	140.2	88.4	223.7	181.7	138.7	237.7	156.7

* When using 17mm insert fittings with design pressure over 3.5 bar, it is recommended that stainless steel clamps be installed on each fitting.

BEST SUB-SURFACE APPLICATIONS

- Curves and edges
- Narrow turf areas
- Large turf areas
- Sub-surface shrub and ground cover areas
- Near buildings
- Adjacent to parking lots
- Small, confined areas
- Athletic Fields

BENEFITS OF SUB-SURFACE DRIP IRRIGATION

- Increased efficiency
- Lower water use
- Elimination of overspray
- Resistant to vandalism
- Healthy plant growth
- Increased watering uniformity
- No damage to fences or trees
- Less water run-off into sewers & drains
- Lower maintenance
- Increased time for field or turf usage
- No wind issues
- Less evaporative loss

AREAS WHERE OVERSPRAY MUST BE AVOIDED

It is a challenge to avoid overspray in narrow turf areas along a roadway, narrow parking strip, or car dealership. These examples show how subsurface drip irrigation can avoid overspray by irrigating from below grade.



Narrow strips or next to roadways



Adjacent to buildings or hardscapes



Car dealerships or parking lots

Adjust for trees

Trees. With any irrigation strategy, it is recommended that trees planted in grassy areas should be irrigated on a different zone than the turf grass. This is particularly true with subsurface drip because over time, tree roots could push the buried subsurface drip lines up to the surface. Also, trees are more valuable than grass, so if the zone for the grass area needs to be turned off to reduce water consumption, then a separate zone for the trees can still be operated to maintain health.

**XFS DRIPLINE
WITH COPPER SHIELD™ TECHNOLOGY**



Recommended

The tree is on a separate zone and there is full separation between the tree and the turf grass.



Acceptable

Although the tree and turf grass are on the same zone, the buried dripline should be placed far enough away from the trunk so that tree roots do not push the dripline to the surface.



Not recommended

There is no additional water for the tree. The dripline is close to the trunk and the tree roots will probably push the buried dripline up to the surface.

Adjust for curved edges

Curved Edges. Rain Bird XFS Dripline with Copper Shield™ is flexible to follow curves that are 3 inch (7.6cm) in radius and larger. When there are curved shapes in the landscape, avoid designing dripline rows that follow the curved edges of the landscape. Instead, lay out as many straight lines as possible to simplify the installation, then fill in missed areas with additional straight lines if possible. When the landscape design layout is finished, make a grid pattern overlay to scale with the selected emitter and row spacing (for example, a grid that is 12 inches by 18 inches / 30.5cm by 45.7cm). Place the overlay on top of the design and check to be sure that at least one row and not more than two rows are found in each grid. This procedure ensures good uniformity in the design and avoids creating areas that may receive too much or too little water.

When installed on bare ground, specify Rain Bird stakes to hold tubing in place and pin the dripline with stakes every 5 feet (1.52m) on straight runs; and every foot when following a curve of 4 foot (1.22m) radius or less. Stakes are not required if the dripline is installed directly in the ground with mechanical equipment. (see page 31)

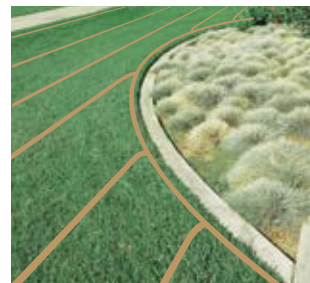

Recommended



Not Recommended



XFS DRIPLINE
WITH COPPER SHIELD™ TECHNOLOGY

DESIGN FOR A CONFINED AREA

What follows is a step by step process for the final grid layout and header design. This process is shown for small, confined areas. It is recommended to put the driplines 4 inches (10.2cm) below finished grade. If the turf area will be aerated, the driplines should lie 6 inches (15.24cm) below grade.

Lay out the final grid pattern, design the supply header, and flush headers

Establish the overall grid concept. Generally, the least cost grid design is to place the header along the short dimension and design rows to run the length of the long dimension. This reduces the header material cost and will have fewer connections.

- A. Identify the zone boundaries and show the direction of the dripline row.
- B. Determine the maximum row length from Table 7 on page 24. The chart gives the maximum length for a given pressure at the lateral inlet (not the pressure available at the water source).
 1. To choose the maximum row length at this step, estimate the inlet pressure available at the row that is farthest away from the water source.
 2. Perform a pressure loss calculation from the water source to the farthest end of the header to confirm that all driplines will have adequate pressure. Be sure to account for changes in elevation.
- C. Specify the distance from the edge of the zone to the first row in the grid.
 1. For turf that is planted against a hardscape edge or curb, the first row should be 2 inches (5cm) away from the edge.
 2. For turf that is adjacent to a planted area, the first row should be 4 inches (10.2cm) away from the edge.
- D. Measure the widest part of the zone and specify the number of rows. (see page 14 for an example)
 1. Find the widest zone dimension (in inches or centimeters).
 2. Subtract the specified distance from both edges.
 3. Divide by the spacing between rows, and round up to the nearest whole number.
 4. Add 1 to this number to find the exact number of rows in the grid.
- E. Design a header system that provides the pressure that was assumed in step B above to each of the rows.
 1. For small areas with less than 8 GPM (30.28 L) total flow, the header can be made of polyethylene tubing, either with or without emitters.
 2. For larger confined areas, divide the zone into subsections with no more than 8 GPM (30.28 L) flow and design a polyethylene header system for each of these subsections.
- F. Repeat the process at the opposite end of the zone to design flush headers and connect the flush headers to a manual or automatic valve so that the entire grid can be flushed regularly.



XF5 DRIPLINE WITH COPPER SHIELD™ TECHNOLOGY

DESIGN FOR LARGE AREAS

A procedure is shown on pages 10 and 11 for larger applications where the zone boundaries are not naturally defined.

Lay out the final grid pattern, design the supply header, and flush headers

Establish the overall grid concept. For the most cost-effective design, the maximum row length determines the long dimension of the zone and the total available water flow determines the number of rows. Most large systems use a supply header in the middle of a zone and rows are installed in opposite directions from the center of the zone to reduce friction loss. (see Center Feed Layout diagram on page 10)

- A. Determine the maximum row length from Table 7 on page 24. Estimate the inlet pressure at the row that is farthest away from the water source.
- B. Calculate the flow rate of the longest row by multiplying the number of emitters by the flow rate of each emitter.
- C. Divide the flow rate available at the water source by the flow rate of the longest row and round down to find the maximum number of rows that can be irrigated in one zone.
- D. Design water supply and flush headers to supply the rows, using the spacing between rows as selected for the soil type. In large systems, large diameter PVC or poly pipe is often used to supply water to a riser that feeds rows in opposite directions.
 1. Header designs should be specified with minimal friction loss to be sure of adequate pressure at the inlet of each lateral.
 2. Headers should be designed to limit the water velocity to no more than 5 feet (1.5m) per second to reduce friction loss, reduce long-term wear and hydraulic water hammer. (see Table 4 on page 15)
 3. Perform a pressure loss calculation from the water source to the farthest end of the header to confirm that all driplines will have adequate pressure. Be sure to account for changes in elevation.
- E. Specify air vents as per standard design practice for the large diameter water supply piping.
- F. Repeat the process at the opposite end of the zone to design flush headers and connect the flush headers to a manual or automatic valve so that the entire grid can be flushed regularly.

**SUB-SURFACE
INSTALLATION AND OPERATION**

OPTION A: PRE-GRADED INSTALLATION METHOD

- Remove the soil to a depth of at least 4 inches (10.2cm) below final grade; place the dripline on the soil surface
- Place the dripline grid on a uniform grade that is free of sharp rocks or other objects that may damage the dripline
- Make all connections to the supply header, flush header, flush valve, air relief valve, and control zone kit, then check for leaks before backfill
- Use tie-down stakes to keep the dripline in place while replacing backfill
- Be sure to compact the backfilled soil with rubber-tired machinery or a heavy roller. Some amount of compaction is required for water to move through the capillaries in the soil.



OPTION B: VIBRATORY PLOW (SINGLE OR MULTI-SHANK) METHOD



- A single-shank or multi-shank vibratory plow can be used in new installations on bare soil, or to retrofit under existing turf
- This type installation method is less destructive to existing turf grass
- Be sure to cover the ends of the driplines after each pass to keep soil and debris from entering the lines before they are connected to the headers.



OPTION C: LINE PULLING METHOD

- Line-pulling equipment utilizes a pull blade which has an enlarged “bullet” at the base
- This bullet opens a tunnel at the predetermined depth beneath the ground surface (recommended 4” to 6” deep / 10cm to 15.24cm)
- Start by digging a hole for the line pulling blade (often called the “bullet”) to rest in where the tractor treads are still at finished grade level
- Attach the dripline to this bullet by means of a chain and pulling grip
- As you move forward from the starting hole, the pipe is pulled through this underground tunnel
- Pipe pulling distance will vary, depending on factors such as, ground conditions, soil type and directness of the pulling route



OPTION D: ROTARY TRENCHING METHOD

- A rotary trenching unit cuts a narrow trench approximately 1 inch (2.54cm) wide by 4 to 6 inches (10.2cm to 15.24cm) deep
- Suitable for installations in narrow or small existing turf grass applications
- Also suitable for sub-surface shrub and ground cover installations



OPTION E: HAND TRENCHING METHOD

- Hand trenching maybe be utilized in areas too small for mechanical installation
- Ideal for loamy and sandy soil sub-surface applications in turf grass and shrub bed installation
- Establish finish grade
- Hand dig trenches 4 to 6 inches (10.2cm to 15.24cm) deep to install XFS sub-surface dripline
- Cover trenches and rake level
- If installing shrubs or groundcover, maintain flags to identify dripline location during planting



RECOMMENDED PRACTICES

1. Keep all driplines, headers (manifolds), and mainline piping free of dirt during installation because any contamination in these lines could plug the dripline emitters.
2. Check headers (manifolds) and dripline laterals for leaks before covering with soil.
3. Check pressure at the site and be sure to operate below the maximum rated pressure of 60 PSI (4.14 bar). Check and record pressure at the supply header and flush header. Any changes in pressure can be used in future troubleshooting.
4. If core aeration is expected to be done in the turf where sub-surface dripline is installed, be sure the tine depth is less than the depth of the buried dripline. Depth of dripline is recommended to be 6" (15.24cm) while tine depth should not be set greater than 4" (10.2cm).
5. When using machinery for the installation:
 - a. Do not drive over the dripline; always keep a layer of soil between the dripline and machinery tires.
 - b. To help keep driplines in place, drive in the same direction as the dripline, not across the lines.
 - c. Avoid driving in the same places at the site or you will be creating heavily compacted areas.
6. Be sure there is uniform soil compaction all over the site after installation.
7. After installation, open the flush valves (one at a time) and collect some of the water to check to be sure that the installation is clean.
8. After installation and backfill, observe the first wetting pattern. Rapid puddling could indicate a leak or might mean that the driplines are not buried at the specified depth.
9. Allow for expansion and contraction of tubing.
 - ↳ **Conservative estimate of expansion and contraction:**
 - a. 0.1 inch per 100' for every 1° F of temperature change
[Example: 260' tubing length and 40° F temperature change]
 - b. $2.6 (100' \text{ length}) \times 0.1 (\text{in}/100') \times 40 (\text{degrees F}) = 10.4''$
or 1.5cm per 100 meters for every 1° C of temperature change
 - c. 120 M tubing length and 5° C of temperature change
 - d. $1.2 (100 \text{ M length}) \times 1.5 (\text{cm}/100\text{m}) \times 5 (\text{degree C}) = 9 \text{ cm}$



Ensure that installation depth is consistent throughout the installation

1/4" LANDSCAPE DRIPLINE

Rain Bird 1/4" Dripline is a perfect choice for small-sized areas such as planter boxes, container gardens, loops around trees, vegetable gardens and shrubs.

Features

- Simple to use, as the flexible tubing makes watering pots and container gardens easy
 - 1/4" tubing size complements the aesthetics of any garden
 - Clog resistance through built-in filtration and two outlet holes, 180 degrees apart
- Brown tubing complements Rain Bird XF Dripline
 - Unobtrusive size and flexibility provide a low-profile, aesthetically pleasing means to irrigate plants
- Works with Rain Bird 1/4" barbed Fittings
- Comes in 2 spacings, 6" (15.25 cm) and 12" (30.5 cm) and a coil length of 100' (30.5 m) for design flexibility

Operating Range

- 10 to 40 psi (0.7 to 2.7 bar)
- Flow rate at 30 psi (2.0 bar): 0.8 gph (3.0 l/h)
- Required filtration: 200 mesh (75 microns)

Specifications

- Outside diameter: 0.250" (6 mm)
- Inside diameter: 0.170" (4 mm)
- Wall thickness: 0.040" (1 mm)
- Spacing: 6" or 12" (15.25 cm and 30.5 cm)
- Length: 100' (30.5 m) coils

Models

- LDQ-08-06-100
- LDQ-08-12-100



Flow Characteristics						
Model	Flow at 30psi		Spacing		Coil Length	
	(gph)	(l/h)	(in.)	(cm)	(ft.)	(m)
LDQ-08-06-100	0.8	3.0	6	15.25	100	30.50
LDQ-08-12-100	0.8	3.0	12	30.5	100	30.5

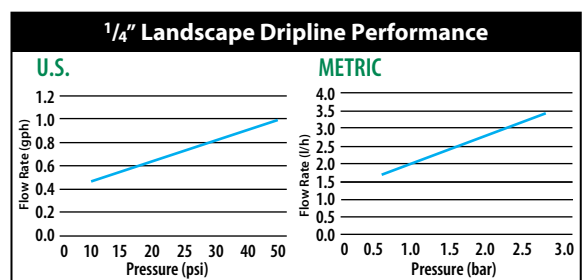

TABLE 9: LATERAL RUN LENGTHS

Maximum Length of Run (Feet)		
Emitter Spacing	Maximum Length of Run	Flow per Ft. @ 15psi
6"	19 feet	1 gph/ft
12"	33 feet	0.5 gph/ft

CONTROL ZONE KITS



Rain Bird Control Zone Kits provide all of the components necessary for on/off control, filtration and pressure regulation of a low-volume irrigation zone, making the kits simple to order and easy to install.

KIT FEATURES



LOW FLOW VALVES

Featured on the following models: **XCZ-075-PRF and XCZ-LF-100**

- The only valve on the market that can handle low flows below 3 gpm (11.4 l/min) without weeping (Low Flow DV Drip Valve)



ANTI-SIPHON VALVE

Featured on the **XACZ-075-PRF and XACZ-100-PRF models**

- Field-proven low flow anti-siphon valve that has an atmospheric vacuum breaker for backflow prevention and an IAPMO rating



SHORTER KITS

- With only two components (valve plus pressure regulating filter) you can fit more Control Zone Kits in a valve box, saving time and money



PR FILTER KITS

Featured on the following models: **XCZ-075-PRF, XCZ-LF-100, XCZF-175-PRF, XACZ-075-PRF, XCZ-100-PRF, XCZF-100-PRF, and XACZ-100-PRF**

- All of these kits provide on/off control, filtration, and built-in pressure regulation with fewer components so there is less chance of leakage at the connections, both at installation and over the life of the system

SECTION 7: SPECIFYING PRODUCTS IN THE ZONE

<http://www.rainbird.com/czk>

QUICK-CHECK FILTER WITH PRESSURE REGULATION AND FILTRATION ALL IN ONE

Featured on the following models: **XCZ-100-PRB-COM & XCZ-150-PRB-COM**



GREEN INDICATES A CLEAN FILTER



RED INDICATES A DIRTY FILTER

- Save labor and time with the simple-to-check indicator bubble and easy-to-clean stainless steel screen
- The filter design allows the element to be accessed vertically while preventing debris from falling into the line
- Efficient design combines filtration and pressure regulation in one compact unit
- Fewer connection points mean less chance of leaking and less assembly time
- The body is made of durable, glass filled nylon
- Replacement stainless steel screens also available separately in 50, 100, 150, and 200 mesh



SCRUBBER VALVE





Featured on the following models: **XCZ-100-PRB-COM & XCZ-150-PRB-COM**



- Plastic scrubber scrapes the stainless steel screen to clean and break down grit and organic materials
- Slow closing prevents water hammer and subsequent system damage
- Fabric-reinforced diaphragm adds strength and durability

SPECIFYING CONTROL ZONE KIT SELECTION CHART

FLOW RATE:

-  Residential / Light Commercial
LOW Flow: 0.2 - 5 gpm
-  Residential / Light Commercial
MEDIUM Flow: 3 - 15 gpm
-  Commercial
MEDIUM PLUS Flow: 3 - 20 gpm
-  Commercial
HIGH Flow: 15 - 40 gpm



XCZ-075-PRF
Low Flow | Control Zone Kit
with PR Filter

VALVE:
3/4" Low Flow DV Drip Valve with
3/4" Pressure Regulating RBY Filter

INLET X OUTLET SIZE:
3/4" FPT x 3/4" MPT

FLOW:
0.2 - 5 gpm

INLET PRESSURE:
15 -120 psi

OUTLET PRESSURE:
Regulated at 30 psi

FILTRATION:
200 mesh stainless steel screen



XCZ-LF-100
Low Flow | Control Zone Kit
with PR Filter

VALVE:
1" Low Flow DV Drip Valve with 3/4"
Pressure Regulating RBY Filter, and
MDCF Fitting (16-17 mm tubing)

INLET X OUTLET SIZE:
1" FPT x 3/4" MPT (Includes MDCF)

FLOW:
0.2 - 5 gpm

INLET PRESSURE:
15 -120 psi

OUTLET PRESSURE:
Regulated at 30 psi

FILTRATION:
200 mesh stainless steel screen



XACZ-075-PRF
Low Flow | Control Zone Kit with
Anti-Siphon Valve and PR Filter

VALVE:
3/4" Low Flow DV Drip Anti-Siphon
Valve with 3/4" Pressure Regulating
RBY Filter

INLET X OUTLET SIZE:
3/4" NPT x 3/4" NPT

FLOW:
0.2 - 5 gpm

INLET PRESSURE:
15 -120 psi

OUTLET PRESSURE:
Regulated at 30 psi

FILTRATION:
200 mesh stainless steel screen



XCZF-175-PRF
Medium Flow | Control Zone Kit
with PR Filter and Flow Control

VALVE:
1" DVF Valve with 3/4" Pressure
Regulating RBY Filter, and MDCF
Fitting (16-17 mm tubing)

INLET X OUTLET SIZE:
1" FPT x 3/4" MPT (Includes MDCF)

FLOW:
3 - 10 gpm

INLET PRESSURE:
15 -120 psi

OUTLET PRESSURE:
Regulated at 30 psi

FILTRATION:
200 mesh stainless steel screen



XCZ-100-PRF
Medium Flow | Control Zone
Kit with PR Filter

VALVE:
1" DV Valve with 1" Pressure
Regulating RBY Filter

INLET X OUTLET SIZE:
1" FPT x 1" MPT

FLOW:
3 - 15 gpm

INLET PRESSURE:
15 - 120 psi

OUTLET PRESSURE:
Regulated at 40 psi

FILTRATION:
200 mesh stainless steel screen



XCZF-100-PRF
Medium Flow | Control Zone
Kit with PR Filter



VALVE:
1" DVF Valve with 1" Pressure
Regulating RBY Filter

INLET X OUTLET SIZE:
1" FPT x 1" MPT

FLOW:
3 - 15 gpm

INLET PRESSURE:
15 -120 psi

OUTLET PRESSURE:
Regulated at 40 psi

FILTRATION:
200 mesh stainless steel screen



XACZ-100-PRF
Medium Flow | Control Zone Kit
with Anti-Siphon Valve and PR Filter



VALVE:
1" Anti-Siphon Valve with 1"
Pressure Regulating RBY Filter

INLET X OUTLET SIZE:
1" FPT x 1" MPT

FLOW:
3 - 15 gpm

INLET PRESSURE:
15 -120 psi

OUTLET PRESSURE:
Regulated at 40 psi

FILTRATION:
200 mesh stainless steel screen



XCZ-100-PRB-COM
Medium Flow | Commercial Control Zone
Kit with PR Quick-Check Basket Filters



VALVE:
1" Ball Valve with 1" PESB Valve and 1"
Pressure Regulating Basket Filter

INLET X OUTLET SIZE:
1" FPT x 1" MPT

FLOW:
3 - 20 gpm

INLET PRESSURE:
15 -150 psi

OUTLET PRESSURE:
Regulated at 40 psi

FILTRATION:
200 mesh stainless steel screen

TEMPERATURE:
Up to 150° F



XCZ-100-PRB-LC
Medium Flow | Light Commercial
Control Zone Kit with PR Basket Filter



VALVE:
1" PGA Valve with 1" Pressure
Regulating Basket Filter

INLET X OUTLET SIZE:
1" FPT x 1" MPT

FLOW:
3 - 20 gpm

INLET PRESSURE:
15 - 150 psi

OUTLET PRESSURE:
Regulated at 40 psi

FILTRATION:
200 mesh (75 micron)

TEMPERATURE:
Up to 150° F



XCZ-100-PRBR
Medium Flow | Commercial Control
Zone Kit with PR Basket Filter



VALVE:
1" PESBR Valve with 1" Pressure
Regulating Basket Filter

INLET X OUTLET SIZE:
1" FPT x 1" MPT

FLOW:
3 - 20 gpm

INLET PRESSURE:
15 - 150 psi

OUTLET PRESSURE:
Regulated at 40 psi

FILTRATION:
200 mesh (75 micron)

TEMPERATURE:
Up to 150° F



XCZ-150-PRB-COM
High Flow | Commercial Control Zone Kit
with 2 PR Quick-Check Basket Filters



VALVE:
1.5" PESB Valve with two 1" Pressure
Regulating Quick-Check Basket Filters

INLET X OUTLET SIZE:
1.5" FPT x 1" MPT

FLOW:
15 - 40 gpm

INLET PRESSURE:
20 - 150 psi

OUTLET PRESSURE:
Regulated at 40 psi

FILTRATION:
200 mesh (75 micron)

TEMPERATURE:
Up to 150° F

SPECIFYING PRODUCTS IN THE ZONE

Rain Bird offers a full line of fittings in two types: 17mm insert fittings are designed for use with XF Series dripline. Rain Bird's Easy Fit compression fittings handle XF Series and other dripline and tubing sizes from 16mm to 17mm OD.

XF SERIES | 17MM INSERT FITTINGS



Rain Bird's 17mm Insert Fittings have a barbed end that is raised and sharp providing a strong connection. This fitting is rated for operating pressures up to 50 psi (3.45 bar) without using clamps. If operating pressures exceed 50 psi (3.45 bar), a clamp is recommended. To install, the fittings are pressed into the tubing. It is important you do not heat the polyethylene tube before inserting to make installation easier, as it will weaken the connection and can damage the tubing. For the full line of insert fittings, refer to our website at www.rainbird.com/distribution or consult a Rain Bird product catalog.

Features:

- Complete line of 17mm insert fittings to simplify installation of XF Series Dripline
- High quality barbs grab tubing for a secure fit
- Unique barb design to reduce insertion force and still retain a secure fit
- Non-obtrusive colored fittings to compliment natural earth tones



17mm Fitting Models



Model:
XFF-COUP
Description:
17mm Barb x Barb Coupling



Model:
XFF-TEE
Description:
17mm Barb x Barb x Barb Tee



Model:
XFF-ELBOW
Description:
17mm Barb x Barb Elbow



Model:
XFF-TMA-050
Description:
17mm Barb x 1/2" MPT x 17mm Barb Tee Male Adapter



Model:
XFF-MA-050
Description:
17mm Barb x 1/2" MPT Male Adapter



Model:
XFF-MA-075
Description:
17mm Barb x 3/4" MPT Male Adapter

Also Available



Model:
XFD-CROSS
Description:
Barb cross 17mm x 17mm x 17mm x 17mm



XFD-TFA-075:
Barb tee female adapter
Description:
17mm x 3/4" FPT x 17mm



XFD-FA-075:
Barb female adapter
Description:
17mm x 3/4" FPT

XF SERIES | INSERTION TOOL

Rain Bird's XF Insertion Tool assists you with installing XF Series 17mm Fittings in less time and less effort. The XF Insertion Tool securely locks fittings into place to make inserting into dripline much easier. The handles on either side of the tool can be used to flair out the ends of the dripline. The tool also has a sloped valley to allow room for the dripline when inserting onto the second side.



Compatibility:

Insertion tool can be used to install XF Coupling, Elbow, and Tee fittings.



Model:
FITINS-TOOL



XF SERIES | EASY FIT COMPRESSION FITTINGS

Rain Bird patented Easy Fit compression fittings go together with half the force as insert fittings and can be used on dripline and tubing with diameters from 16 to 17mm OD. Snap-in adapters provide versatility to eliminate the inventory of over 160 combinations of connections. The Easy Fit compression fittings provide a stronger connection and can be used with operating pressures up to 60 psi (4.14 bar). For the full line of Easy Fit fittings, refer to our website at www.rainbird.com/drip/fittings or consult a Rain Bird product catalog.



Model: MDCF-50-MPT
Description:
1/2" MPT x Compression adapter for easy fit fitting



Model: MDCF-75-MPT
Description:
3/4" MPT x Compression adapter for easy fit fitting



Model: MDCF-EL
Description:
16mm Compression x Compression Elbow



Model: MDCF-50-FPT
Description:
1/2" FPT x Compression adapter for easy fit fitting



Model: MDCF-75-FPT
Description:
3/4" FPT x Compression adapter for easy fit fitting



Model: MDCF-TEE
Description:
16mm Compression x Compression Tee



Model: MDCF-75-FHT
Description:
3/4" FHT x Compression adapter for easy fit fitting



Model: MDCF-COUP
Description:
16mm Compression x Compression Coupling



Models: MDCF-CAP (Black)
MDCFP-CAP (Purple)
Description:
16mm Compression x Compression Coupling

SPRAY-TO-DRIP RETROFIT KITS

Convert any Spray Zone to a Drip Zone.

The easiest and fastest way to convert a conventional spray zone to a low-volume irrigation zone.

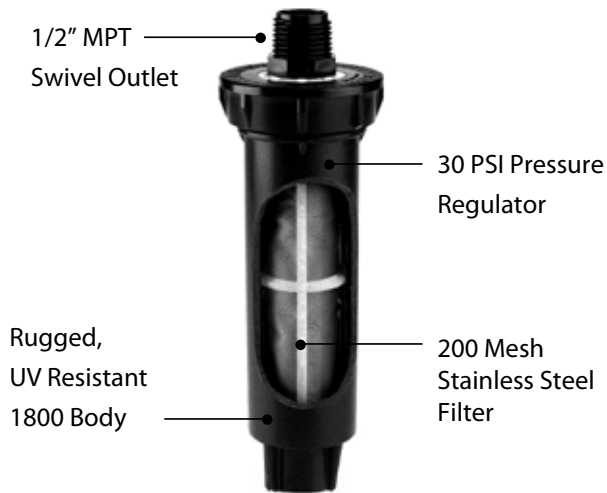

SPECIFYING PRODUCTS IN THE ZONE

INSTALLATION

- Simply remove the top of any 1800 and remove the internal assembly (on the 1806 and 1812 leave the spring in the body)
- Remove the internal assembly of the retro kit and drop it into the existing body
- Tighten the cap
- Use Easy Fit Fittings or a female adapter to connect to drip tubing
- Cap off all other spray heads in the zone using Xeri-Caps™

FEATURES

- Can be installed above or below grade.
- Provides 30 psi (2.1 bar) pressure regulation and 200 mesh (75 microns) screen.
- Flow rate 0.50 to 4.00 gpm.

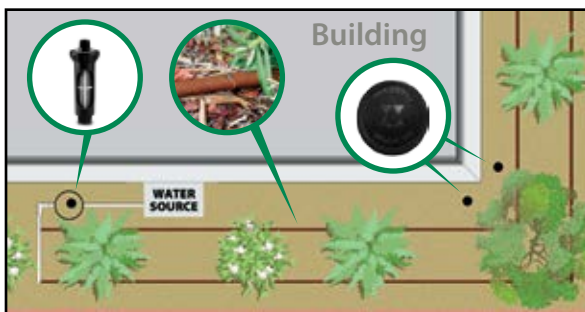

CURRENT APPLICATION

Products

- 1800 with sprays

Issues

- Overspray damage to structure, fence, windows
- Water loss to wind
- Runoff liability in high wind traffic areas

DRIP SOLUTION

Products

- Retrofit Kit (1800-Retro)
- Xeri-Caps (1800-XC)
- XF Tubing
- MDCF Fittings
- 17mm XF Insert Fittings

Advantages

- Reduce the effects of wind and evaporation by 30%-70%
- No runoff
- No overspray damage
- XF easy to install

AIR/VACUUM RELIEF VALVES

Air/Vacuum Relief Valves are used for two reasons:

- To allow air into a zone at the end of a watering cycle. This ensures a vacuum doesn't draw debris into the dripline. (Back siphoning)
- To ensure release of air from a zone at the start of watering, eliminating air pockets. This speeds fill time, thus increasing watering uniformity across the zone.

Install Air/Vacuum Relief Valves correctly by:

- Locating the highest point(s) of the dripline zone.
- Install the valve in an exhaust header or a line that runs perpendicular to the lateral rows to ensure all rows of the dripline can take advantage of the air/vacuum relief valve.



SEB 7XB emitter box (Sold Separately)



MODELS

1/2" Air Relief Valve
Model: ARV050

SPECIFYING

PRODUCTS IN THE ZONE

TABLE 10: LATERAL RUN LENGTHS

Maximum length of dripline that can be used with the Air Relief Valve (ARV)

Emitter Spacing	1/2" ARV	
	0.61 GPH	0.92 GPH
12"	639 ft	424 ft
18"	958 ft	636 ft
24"	1,278 ft	848 ft

Air Relief Valve capacity

	1/2" ARV
Total Flow (GPM)	6.5
Total Flow (GPH)	390

ARV should be installed at the high points in the drip zone for proper operation and reduced risk of back siphoning.

TIE-DOWN STAKES



XF Series tie-down stakes (TDS-050) are used to hold dripline in place. Designed with notch sides for better hold down strength, they are made of long lasting corrosion resistant 12-gauge galvanized steel. Use stakes to hold dripline on-surface or under a mulch cover. For best results, stagger stakes every 3 feet (.91 m) in sand, 4 feet (1.22m) in loam, and 5 feet (1.52m) in clay. At fittings where there is a change of direction such as tees or elbows, use tie-down stakes close to the fitting on each leg of the change of direction.

MANUAL LINE FLUSH POINT

A manual flush is used when flushing lines in the system or when emptying the system when preparing for winter.

- Install the manual flush at a low point in the exhaust header of a grid layout, or at the mid-point of a Loop Layout. (see pages 10,11)
- Install a flush port with a threaded plug or a manual flushing valve in a valve box with a gravel sump adequate to drain approximately one gallon of water
- Manual flush points are normally installed as far away from the water source as possible



DRIP SYSTEM OPERATION INDICATOR

Features

- Stem rises 6" for clear visibility
- When stem is extended, drip system is charged to a minimum of 20 psi
- Van nozzle is tightened to no flow but can be opened to observe wetting pattern
- Includes 16" of 1/4" distribution tubing with 1/4" connection fitting pre-installed

Model

- OPERIND

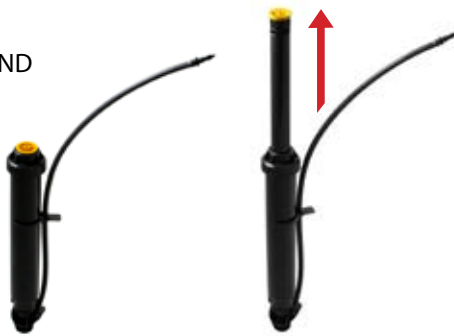

System is OFF

System is ON

SPECIFYING PRODUCTS IN THE ZONE



Installation of Operation Indicator with XFD On-Surface Dripline

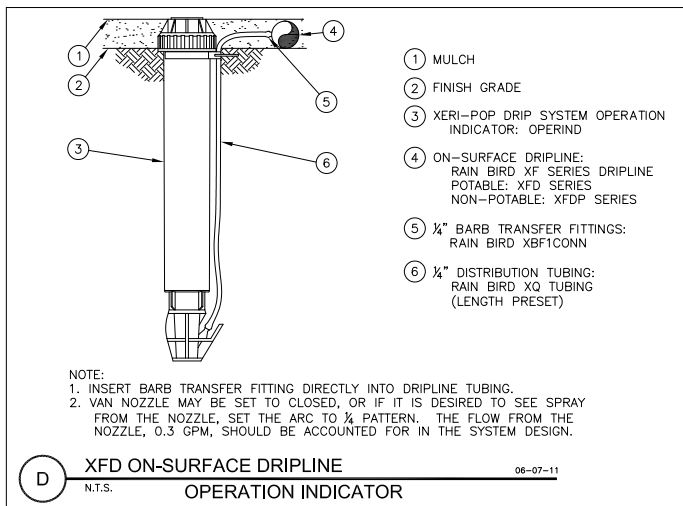

Installation of Operation Indicator with XFS Sub-Surface Dripline

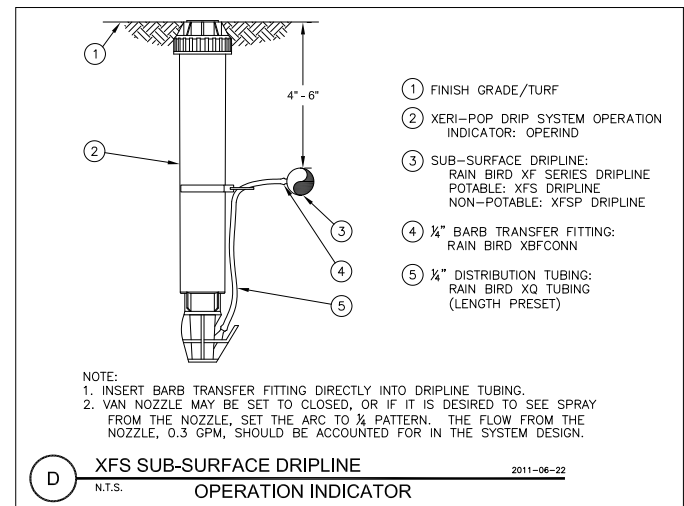

SECTION 8: MAINTENANCE AND INSTALLATION TIPS

XF SERIES DRIPLINE INSERT ADAPTERS FOR 1" (2.54 CM) AND 1 1/2" (3.81 CM) OR LARGER PVC

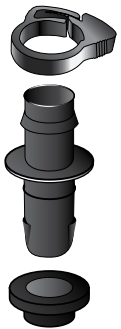

- Connects XF Series Dripline and Blank Tubing to PVC mainlines at low pressures.
- UV stabilized for long life
- Easy to use Ratchet Clamp secures tubing to adapter

MODEL

- For 1" PVC:** XPVCADP
- For 1.5" PVC:** XFDINPVC

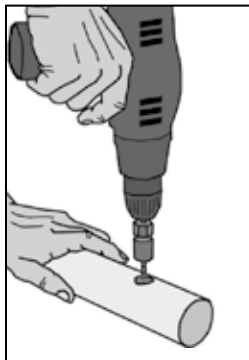

Drill hole using 5/8" hole saw size. Use low speed drill. Remove burrs from hole.

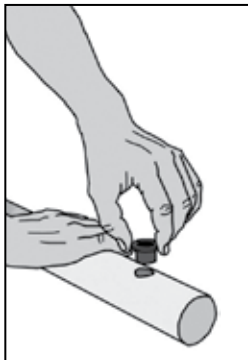

Remove shavings and place appropriate grommet firmly in hole with flange facing out.

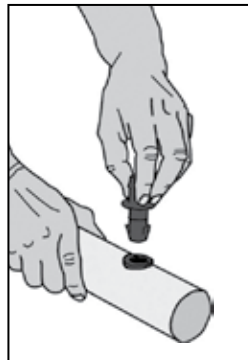

Push XF Series Dripline Insert Adapter into grommet until flange and grommet are flush.

Recommended Accessories

Drill Bit for 1" PVC:
Part# XPVCBIT

Note: For 1.5" PVC, use a standard 5/8" drill bit.

SUB-HEADER MANIFOLD

- You may reduce the number of glued fittings, saddles or insert adapter fittings.
- Total gallonage within the sub-header manifold should not exceed 5 GPM.

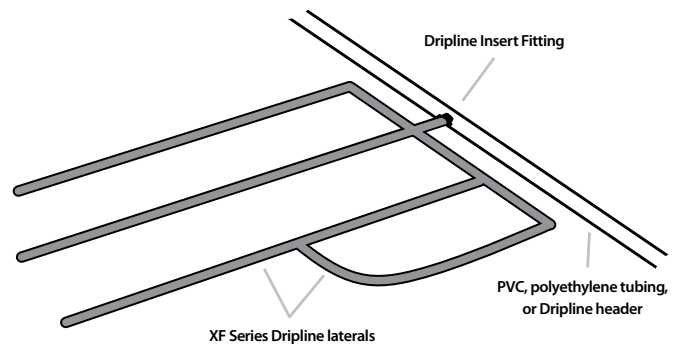

FLUSHING

- Flush the system every two weeks for the first 6 weeks and check the water that is flushed out for cleanliness
- Establish a regular flush schedule for the future after these initial checks
- Flush the system well after any repairs are made
- Check the pressure at the supply and flush headers on a regular basis and compare with the pressure readings taken right after installation

WINTERIZING

- Winterizing an irrigation system involves removing enough water to ensure that components are not damaged due to freezing weather
- Check the manufacturer's instructions for winterizing the valves, filters and backflow prevention devices

If compressed air is used to blowout the lines:

- Compressed air may be used only be used with the flush valve open and with the air pressure at 40 psi (2.76 bar) or less
- XF Series Dripline fittings are rated to 50 psi (3.45 bar), so the air pressure must be adjusted below this pressure
- It is air volume, not pressure, which is effective when blowing out the lines
- The pressure-regulating valve that is part of the control zone regulates water, not air pressure
- With all drain ports open, compressed air should be applied until no water is seen exiting the ports
- After turning off the air, close all drain ports

If compressed air is not used to blowout the lines:

- A drain port should be installed at all low points in the zone. These ports may be a tee or elbow with a threaded plug or a manual flush valve
- If the zone is in a grid or closed loop system, the headers may contain a significant amount of water because they are either blank XF Series tubing, PVC, or poly pipe. It is important to provide drain ports for these components
- If the zone has laterals that dead-end and are not connected to an exhaust header, the lateral ends should be opened to drain at the lowest point(s)

PREVENTATIVE MAINTENANCE

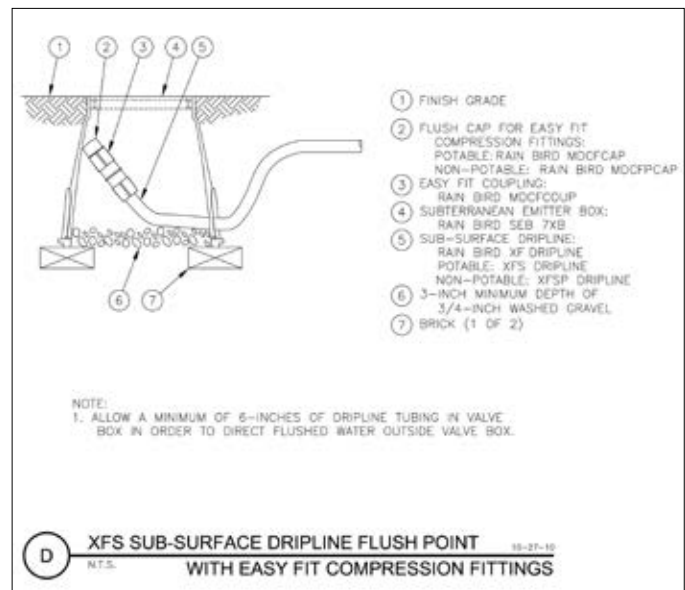

SPECIFICATIONS

WRITTEN SPECIFICATIONS AND CAD DETAIL DRAWINGS

- Rain Bird’s technical specifications for commercial products are now available in Microsoft Word format. For your convenience, these technical specifications can be easily edited or cut and pasted into your documents and drawings, saving you time and money.

Visit written specifications page: <http://www.rainbird.com/Indwrittenspecs>

- Rain Bird CAD Detail Drawings for Landscape Irrigation products are now available in four popular formats: DWG for AutoCad users, DXF for importing into alternate CAD programs, JPG for most web browsers and Microsoft Office users and PDF for printing and emailing to clients.

Visit CAD drawings page: <http://www.rainbird.com/dripdetails>

Sample CAD Drawing

- ① PVC SUPPLY PIPE FROM RAIN BIRD CONTROL ZONE KIT (SIZED TO MEET LATERAL FLOW DEMAND)
- ② PERIMETER OF AREA
- ③ PERIMETER DRIPLINE PIPE TO BE INSTALLED 2"–4" FROM PERIMETER OF AREA
- ④ PVC SUPPLY MANIFOLD
- ⑤ PVC SCH 40 TEE OR EL (TYPICAL)
- ⑥ BARB X MALE FITTING: RAIN BIRD XFD-MA FITTING (TYPICAL)
- ⑦ SUB-SURFACE DRIPLINE: RAIN BIRD XF SERIES DRIPLINE (TYPICAL)
POTABLE: XFS DRIPLINE
NON-POTABLE: XFSP DRIPLINE
- ⑧ BARB X BARB INSERT TEE: RAIN BIRD XFD-TEE (TYPICAL)
- ⑨ TOTAL LENGTH OF SELECTED DRIPLINE SHOULD NOT EXCEED LENGTH SHOWN IN TABLE
- ⑩ PVC EXHAUST HEADER
- ⑪ FLUSH POINT: SEE RAIN BIRD DETAIL "XFS FLUSH POINT"
- ⑫ PVC SCH 40 RISER PIPE
- ⑬ TURF OR MULCH
- ⑭ FINISH GRADE
- ⑮ AIR RELIEF VALVE: RAIN BIRD AR VALVE KIT XXX
SEE RAIN BIRD DETAIL "XFS AIR RELIEF VALVE KIT"

NOTES:

1. DISTANCE BETWEEN LATERAL ROWS AND EMITTER SPACING TO BE BASED ON SOIL TYPE, PLANT MATERIALS AND CHANGES IN ELEVATION. SEE INSTALLATION SPECIFICATIONS ON RAIN BIRD WEB SITE (WWW.RAINBIRD.COM) FOR SUGGESTED SPACING.
2. LENGTH OF LONGEST DRIPLINE LATERAL SHOULD NOT EXCEED THE MAXIMUM SPACING SHOWN IN THE ACCOMPANYING TABLE.

PSI	XFS Dripline Maximum Lateral Lengths (Feet)					
	12" Spacing		18" Spacing		24" Spacing	
	0.6 GPH	0.9 GPH	0.6 GPH	0.9 GPH	0.6 GPH	0.9 GPH
15	273	155	314	250	424	322
20	318	169	353	294	508	368
30	360	230	413	350	586	414
40	395	255	465	402	652	474
50	417	285	528	420	720	488
60	460	290	596	455	780	512

WHEN USING 17MM INSERT FITTINGS WITH DESIGN PRESSURE OVER 50PSI, IT IS RECOMMENDED THAT STAINLESS STEEL CLAMPS BE INSTALLED ON EACH FITTING.

D XFS SUB-SURFACE DRIPLINE
N.T.S. TYPICAL ODD CURVES LAYOUT

XFS Dripline Odd Curves Layout.dwg

3-17-11

How do I know if the drip system is actually working?

A Rain Bird Xeri-Pop XP-600X with a Rain Bird Variable Arc Nozzle can be installed on an XF Series dripline zone. During operation the Xeri-Pop will provide a visual indication that the drip zone is performing as designed. (see page 38)

What can I expect to achieve in regards to water savings?

It is generally accepted that drip irrigation is over 90% because it delivers water directly to the plant root zone. Also, when compared to sprinklers, drip irrigation can save water by reducing the effects of wind and evaporation from 30% to 70%.

How does the Rain Bird Copper Shield™ work?

Rain Bird's Copper Shield™ protects the emitter from root intrusion without harming the plants or other roots. When a root tries to intrude into the emitter, it comes in close proximity to the copper shield and copper ions are released. These copper ions bind themselves to the attacking root tip and stops it from advancing, thus protecting the emitter.

Will I see striping in the turf?

A well designed, installed and maintained XFS sub-surface dripline system will provide years of superior turfgrass quality while using significantly less water.

Will the XFS Copper Shield work if it oxidizes?

If the Copper Shield oxidizes, these oxides continue to have copper in them. The emitter continues to be protected because of the copper ions that are still present in the oxidized copper shield.

How long will the copper last?

Testing shows that on average Copper Shield™ will exceed 16 years of life.

What if I need to aerate?

Sub-surface drip irrigation can greatly reduce or eliminate the need for aeration. If core aeration is expected to be done in the turf where sub-surface is to be installed, be sure the tine depth is less than the depth of the buried dripline. Depth of dripline is recommended to be 6" while tine depth should not be set greater than 4".

How do I fertilize my turfgrass areas with an XFS sub-surface drip irrigation system?

There a variety of methods to fertilize turfgrass areas including the following:

- Initiate a manual start on the irrigation controller for the turfgrass zones to bring water to the surface and begin to move the fertilizer into the soil structure
- Apply hand watering to the turfgrass areas to water in the fertilizer
- Apply fertilizer prior to a rainfall event
- Consider the use of fertilizer injection system to provide nutrients to the on-surface shrub bed areas as well as the sub-surface turf areas

**FREQUENTLY
ASKED QUESTIONS**

Can I establish sod with SDI?

An XFS sub-surface dripline system is no different than a spray head or rotary zone of irrigation. Initial water time and frequency should be programmed to allow for the establishment of new sod installations. As with conventional sprinkler systems, some supplemental hand watering maybe needed to be provide coverage to isolated "hot" spots during the establishment period.

Can I germinate seed with SDI?

An XFS sub-surface dripline system is no different than a spray head or rotary zone of irrigation. Initial water time and frequency should be programmed to allow for the establishment of newly seeded areas as it is necessary to keep the seed bed moist during germination.

As with conventional sprinkler system some supplemental hand watering maybe needed to be provide coverage to isolated "hot" spots.

Where can I use XF Series Dripline?

This design guide outlines all of the XF series driplines for use in any on-surface or sub-surface landscape irrigation application. Now that's an intelligent use of water.

Can XF Series Dripline be used with reclaimed water?

XFD for on-surface and XFS for sub-surface applications are available in purple dripline for non-potable water supplies.

What is the life expectancy of the system?

An XF Series on-surface or sub-surface dripline system is no different than any other zone of irrigation. XF Series dripline is made of a dual-layered tubing that provides unmatched resistance to chemicals, algae growth and UV damage. With good design, installation and maintenance an XF Series dripline system will provide many years of reliable service. A dripline zone should be inspected regularly to insure that filters are clean and that the dripline is working properly.

Where can I find out more about Rain Bird XF Series Dripline?

For additional information on the XF Series family of dripline products please visit www.rainbird.com.



**Rain Bird's Professional
Customer Satisfaction Policy**

XF Series Dripline offers five (5) years on product workmanship and seven (7) years on environmental stress cracking

Rain Bird XFS Dripline with Copper Shield™ – Drip tubing that is specifically designed to be buried and to deliver small amounts of water directly to the soil.

Emitter – The device inside the drip tubing that controls the amount of water flow out of each outlet hole.

Supply Header – The combination of flexible or rigid pipe plus fittings that supplies water to many rows of dripline (also known as “manifold”).

Flush Header – Flexible or rigid pipe and fittings connecting a group of dripline rows and found at the opposite end of the Supply Header (also known as “manifold”).

Application Rate – A measurement of the amount of water added to a zone over a certain amount of time, often reported in inches per hour.

Run Time – The amount of time that the valve is open and water is delivered to an irrigated area.

Back Siphoning – The reverse flow of water from the soil and back into the emitter outlet hole. This can happen when there is no check valve or vacuum air relief valve, and water drains out of low-elevation emitters creating a back siphon that pulls water into the emitters at higher levels.

Capillary Action – The movement of water through the soil where the water sticks to the sides of very small passages or capillaries between soil particles.

Precipitation Rate – A measurement of the amount of water added to a zone over a certain amount of time, often reported in inches per hour (same as Application Rate).

Zone – A part of the landscape that gets irrigated at the same time.

Flow Rate – The amount of water that travels through the pipes or the emitters in a given amount of time. Flow rate is normally measured in gallons per minute (gpm) or gallons per hour (gph).

GLOSSARY

Static Pressure – The pressure as measured when there is no flow in the system.

Dynamic Pressure – The pressure as measured when water is flowing in the system.

Aerated (aeration) – The act of creating holes in the turfgrass to loosen the soil and get oxygen to the underground roots.

Friction Loss – The reduction in pressure caused by water flowing in a pipe because of friction created when the flowing water slides against the inside walls of the pipe or tubing.

Pores – The small spaces between soil particles that water can move into (see Capillary Action).

Riser – A pipe or tube that carries water upward from a buried water supply pipe to a fitting or sprinkler.

Flush Valve – A valve that can be opened automatically or manually to discharge the water that is in the system of dripline rows and headers to remove any accumulated dirt or debris.

The Intelligent Use of Water™

LEADERSHIP • EDUCATION • PARTNERSHIPS • PRODUCTS

At Rain Bird, we believe it is our responsibility to develop products and technologies that use water efficiently. Our commitment also extends to education, training and services for our industry and our communities.

The need to conserve water has never been greater. We want to do even more, and with your help, we can. Visit www.rainbird.com for more information about The Intelligent Use of Water.™



Rain Bird Corporation

970 West Sierra Madre Avenue,
Azusa, CA 91702, U.S.A.
Phone: (626) 812-3400
Fax: (626) 812-3411

Rain Bird Technical Services

(800) RAINBIRD (1-800-724-6247)
(U.S. and Canada)

Rain Bird Corporation

6991 East Southpoint Road,
Tucson, AZ, 85706, U.S.A.
Phone: (520) 741-6100 Fax: (520)
741-6522

Specific Hotline

(800) 458-3005 (U.S. and Canada)

Rain Bird International, Inc.

1000 West Sierra Madre Avenue,
Azusa, CA 91702, U.S.A.
Phone: (626) 963-9311
Fax: (626) 852-7343

www.rainbird.com